

www.ekarisma.com



**ONE STOP
FOR ALL
YOUR GIFTS**





Gifts worth getting excited about

Desirable style, quality and innovation come together in Avenue's carefully selected branded ranges.

Brands that make your promotion shine

Avenue continues to be the premier place to shop for quality branded gifts which are perfectly presented for promotion. Our uniquely diverse selection of widely-recognised names together with exclusive, specially-developed promotion-friendly brands gives you the ultimate choice in custom-decorated gifts.

Alongside our proudly gathered collection of internationally trusted names, Avenue's ever-expanding portfolio of promotion-specific brands gives you access to products that are really designed for purpose. Marksman, Seasons, Elevate, iFidelity, Zoom and STAC, now complemented with the addition of BRIGHTtravels, Field & Co and California Innovation, present quality and originality that can't be found in the shops.

Ones to watch in 2016

A plentiful choice of new items across a broad spectrum of categories makes this year's selection more inspiring than ever. From ever-evolving technology and cleverly functional bags to smartly designed stationery items, we've got refreshing solutions for all kinds of situations. For those on-the-move, BRIGHTtravels is a new brand of cleverly thought-through travel accessories. Closer to home, trendy US Basic sunglasses and Seasons' extension into BBQ and picnic accessories brings added pleasure to outdoor entertaining.

Personally yours

All Avenue gifts are selected for their suitability for personalisation. We offer a wide choice of quality decoration options so you can make the best possible impression. Adding your branding to these items delivers a clear and attractive message that gets your business noticed, in the nicest possible way.

Pleasingly impressive promotion.

Avenue

BALMAIN
PARIS



elleven



Paul Bourne



SEASONS



Zoom

MARKS MAN

FIELD & CO.



Jamie Oliver



elleven



WATERMAN
PARIS

SEASONS

MARKS MAN

WHITELINES-LINK
The amazing way to be connected.

Paul Bourne

Zoom

BALMAIN

WATERMAN
PARIS



Jamie Oliver

FIELD & CO.



Paul Bourne



Zoom

Paul Bourne

BALMAIN
PARIS

SEASONS

WHITELINES-LINK
The amazing way to be connected.



WATERMAN
PARIS

FIELD & CO.

Jamie Oliver



elleven



elleven

SEASONS



MARKS MAN

WHITELINES-LINK
The amazing way to be connected.

SEASONS



	Technology	11
	speakers • radios • headphones & earbuds • powerbanks • charging cables • usb hubs • keyboards • smartphone lenses	
	Smartphone, tablet and laptop cases	37
	iPad cases • tablet cases • tablet sleeves • smartphone sleeves • tablet organizer	
	Bags	43
	totes • shoulder bags • conference bags • laptop bags • messenger bags • travel bags • duffel bags • backpacks • slingpacks • tablet bags • trolley bags • sport bags • sailor bags • bowling bags • cooler bags	
	Personal and travel accessories	109
	travel sets • travel organizers • splitters & connectors • wallets • watches	
	Sunglasses	123
	sunglasses	
	Leisure & Sports	131
	outdoor tools • binoculars • running belts • footballs • indoor games	
	Umbrellas	137
	umbrellas	
	Hardware & Safety	149
	torches • flashlights • knives • gift sets • multitools • car accessories • organizers • tool sets	
	Beauty & Wellness	167
	beauty products • bath sets • bathrobes • towels • gift sets	
	Home & Living	173
	coffee sets • wine openers • wine sets • wine coolers • bbq tools • cheese sets • kitchen tools • home decorations • plaids • water sets • aprons • serving trays • cutlery sets • knives • cutting boards	
	Drinkware	205
	bottles • tumblers • flasks • hip flasks • sports bottles • mugs	
	Notebooks & Portfolios	215
	notebooks • portfolios • iPad mini cases • Padfolios	
	Writing Instruments	233
	ballpoint pens • rollerball pens • stylus ballpoint pens • stylus rollerball pens • mechanical pencils • fountain pens • gift sets	



ifidelity
experience originality

Continually updated technology

Technology remains among the most in-demand gifts, and Avenue keeps you in the loop with new possibilities as they become available to the promotional market. For 2016 we are pleased to offer Apple®-certified charging connectors, plus a host of new Bluetooth® headsets and earbuds. Our powerbanks continue to get slimmer and have larger capacity, while also incorporating additional speaker functionality and changeable sleeves which enable easy customisation. Meanwhile the new ifidelity Rollbar Speaker stand is an inspiring alternative design.



ifidelity
experience originality

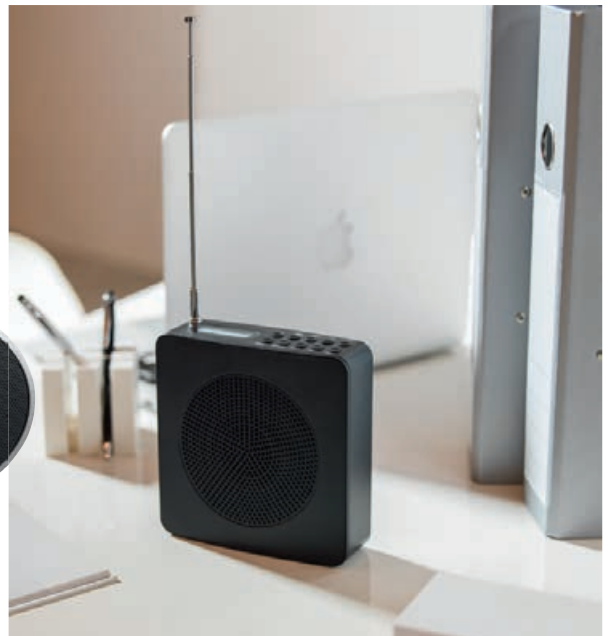

AVENEWS



BRIGHTtravels brings smarter packing to every trip

BRIGHTtravels presents a clever collection of packing solutions that enable you to travel lighter and smarter. Specially designed for holding and organising your in-transit essentials, they take the stress out of packing and make it easy to access the things you need on-the-go. It's time to re-think the way you travel.



FIELD & CO.

On-trend nostalgia, with Field & Co

Fusing nostalgic style with modern-day quality in a highly fashionable look, Field & Co is our new brand of bags. Affordable, yet durable, Field & Co's collections satisfy the promotional market's demand for on-trend products at a less expensive price than comparative retail counterparts.



California Innovation delivers ingenious cooler bag quality.

Since 1986, California Innovation has been leading the way in soft-sided insulated products. Avenue is now delighted to offer a selection from their diverse range of high-quality cooler bags.

Designed for all-round impressive performance, California Innovation's bags complement extensively tested temperature preservation with ergonomically designed shoulder straps, so carrying your cooled refreshments is as comfortable as possible. The inspiring choice of models can be rolled, carried or slung. For the ultimate cooler bag experience, California Innovations has it all!



ELEVATE

Discover Elevate's new entry level bags

Elevate's new Milton range of bags extends the brand's accessibility with four entry level models. Slightly more basic in design than the main range, but maintaining the same great quality Elevate has built its reputation on, these offer sporty style with distinctive blue accents. Next to this fresh Elevate bag collection we also offer a brand new global Elevate apparel collection in our Label catalogue.



Go vintage with Slazenger's Chester bags

Slazenger's new Chester range of bags delivers modern day functionality with vintage styling. The five on-trend models, which includes a laptop bag, are ideal for a variety of different purposes and preferences. Dark blue polyester finished with brown imitation suede details creates a broadly appealing look. Also check the new on-trend retro styled Slazenger apparel collection in our

Label catalogue.





Drinkware as you've never seen it before

On-trend designs and multi-functional purpose bring new dimensions to drinkware for 2016. Geometrically-shaped surfaces and copper-look colouring align well with this year's look. While the ingenious integration of bottle and Bluetooth speaker in a single object makes for two gifts in one.





Decorate it your way

Quality decoration is the finishing personal touch to your gift. With more techniques than ever to choose from, Avenue is pleased to offer the most suitable methods for each type of item. Ensuring that your personal decoration is a true enhancement.



Expand your possibilities with WorldSource

When you're looking for originality beyond our standard catalogue offerings, WorldSource has all the solutions. Flip this brochure around and go to the central section to find out about this infinite world of possibilities.



TECHNOLOGY

BY AVENUE



New



10826500



10826501



10826502



10816002



10816001



10816000



10816004

Avenue



Avenue



COMMANDER BLUETOOTH® SPEAKER

ABS Plastic.

Standing a little over 5cm tall, this speaker packs 2 Watt of quality audio sound. With a built-in volume and music control, mic and LED indicator this speaker has all of the features needed. Includes a Micro-USB charging cable and 3.5mm audio cable. Packed in an Avenue gift box.
ø 5 x 5,5 cm

Compliance: WEEE • Battery Directive • RoHS • R & TTE
Recommended decoration: Padprint

NAIAD BLUETOOTH® SPEAKER

ABS Plastic.

Mini Bluetooth® speaker with 10 meter range wireless connection. The soft touch body gives the speaker a nice quality feeling. Includes a USB power supply and 3.5mm line-in cable. Packed in an Avenue gift box.
ø 4 x 4 cm

Compliance: WEEE • Battery Directive • LVD • MSDS • RoHS • R & TTE
Recommended decoration: Padprint



10822601

10822602

10822600

Avenue



Avenue



JABBA BLUETOOTH® SPEAKER

ABS Plastic.

Quality sound in a small portable Bluetooth® speaker. Play your music or other audio via Bluetooth (10 meters range) or via the 3.5mm audio jack. The built-in microphone, allows you to conference call on-the-go through your smartphone or Skype. Incl. handy carrying strap. Packed in an Avenue gift box.
10,6 x 5,4 x 3,6 cm

Compliance: EMC • WEEE • Battery Directive • LVD • MSDS • RoHS • R & TTE
Recommended decoration: Padprint



10821500

Avenue



TRITON BLUETOOTH® SPEAKER

ABS plastic.

Quality sound in a small portable Bluetooth speaker. Plays your music or other audio from a bluetooth enabled device (10 meters range). The built-in microphone, allows you to conference call on-the-go through your smartphone or Skype. Incl. USB power supply and 3.5mm line in cable.
6 x 6 x 6,2 cm

Compliance: EMC • WEEE • Battery Directive • LVD • MSDS • RoHS • R & TTE
Recommended decoration: Padprint

New



10826400

Avenue



10826401



10826402

Bluetooth

GREEDO BLUETOOTH® SPEAKER

Aluminum.

Enjoy music and movies anywhere by pairing your Bluetooth® compatible device like iPhone, iPad or Android OS devices with this portable aluminum Bluetooth® speaker (10 meters range). With the built-in microphone, the speaker allows you to conference call on-the-go through your smartphone or by video chat programs like Skype. Incl. USB power supply and 3.5mm line-in cable. Packed in an Avenue gift box.

ø 5,6 x 5,9 cm

Compliance: WEEE • Battery Directive • RoHS • R & TTE
Recommended decoration: Padprint

New



10826700

Avenue

Bluetooth

DUKE BLUETOOTH® WATERPROOF SPEAKER

ABS Plastic.

The Duke Bluetooth® Waterproof Speaker (IPX4) features a suction cup and a hook that allows you to stick the product nearly anywhere. The Duke allows you to control music and conference call on-the-go through your smartphone or by video chat programs like Skype, iChat or Google Talk. Incl. lanyard and USB charging cable. The Bluetooth® working range is 10 meters, playback via Bluetooth® up to 6 hours. Packed in a black gift box.

ø 8,9 x 3,8 cm

Compliance: WEEE • Battery Directive • RoHS • R & TTE
Recommended decoration: Padprint

New



10826800

Avenue

Bluetooth

LUMI LIGHT UP BLUETOOTH® SPEAKER

ABS Plastic.

Illuminate your music with this Bluetooth® portable speaker featuring LED lights that pulse to your music for a fun visual experience. Ideal speaker for small parties and outdoor gatherings. Packed in a black gift box.

13,5 x 4,2 x 5,6 cm

Compliance: WEEE • Battery Directive • RoHS • R & TTE
Recommended decoration: Padprint

New



10826901

10826900

Avenue

Bluetooth

KUBUS BLUETOOTH AND NFC SPEAKER

ABS Plastic.

Portable square shape Bluetooth® speaker with 3W output power and NFC function. The NFC allows you to pair NFC enabled devices by simply tapping the device to the speaker. Incl. 3.5mm aux cable and charging cable. Playback time up to 3 hours. Packed in a black gift box.

5 x 5 x 5,1 cm

Compliance: EMC • WEEE • RoHS • R & TTE
Recommended decoration: Padprint



Bluetooth®

10824400

10824401

10824402

10824403

Avenue

NANO BLUETOOTH® SPEAKER

Plastic and silicon.

Exclusively designed by Xmi, small portable speakers in a wide choice of colours; a brighter way to get your message heard. Plays your music or other audio from a Bluetooth enabled device (10 meters range). Playback time up to 6 hours. Packed in an Avenue gift box.
5,4 x 5,4 x 5 cm

Compliance: EMC • WEEE • R & TTE
Recommended decoration: Engraving



Bluetooth®

10821602

10821601

10821603

10821600

Avenue

PADME BLUETOOTH® SPEAKER

ABS plastic.

Enjoy music and movies anywhere by pairing your Bluetooth® compatible device like iPhone, iPad or Android OS devices with this portable Bluetooth speaker (10 meters range). With the built-in microphone, the speaker allows you to conference call on-the-go through your smartphone or by video chat programs like Skype. Incl. USB power supply and 3.5mm line-in cable. Packed in an Avenue gift box.
ø 5,5 x 6,7 cm

Compliance: WEEE • Battery Directive • RoHS • R & TTE
Recommended decoration: Padprint



10826600

Avenue

Bluetooth®

BRAN BLUETOOTH® POWERBANK SPEAKER

ABS Plastic.

The Bran Bluetooth® Speaker is the perfect mobile technology companion. It combines a 2200mAh powerbank (5V/1A output) and Bluetooth speaker (2W output) into one. Incl. Micro to USB charging cable. Packed in an Avenue gift box.
12,3 x 2,7 x 2,7 cm

Compliance: WEEE • Battery Directive • RoHS • R & TTE
Recommended decoration: Padprint



10826300

Avenue

Bluetooth®

ZABRAK BLUETOOTH® SPEAKER

ABS Plastic and Metal.

The Zabrak Powerbank Bluetooth® speaker is the perfect mobile technology companion combining a 4400mAh powerbank and Bluetooth speaker into one. The built-in NFC Technology allows you to connect the speaker to NFC enabled devices by simply tapping the device to the speaker. The built-in microphone allows you to conference call on-the-go through your smartphone or by video chat programs such as Skype, iChat or Google talk. Includes 3.5mm audio cable and USB to Micro USB recharging cable. Packed in an Avenue gift box.
14,5 x 5,3 x 2,5 cm

Compliance: WEEE • Battery Directive • RoHS • R & TTE
Recommended decoration: Padprint

New



12359000

12359001

Avenue

Bluetooth

FUNBOX BLUETOOTH® SPEAKER

ABS Plastic.

The Funbox Bluetooth® speaker comes with a 2x 1.7W output and has up to 4 hours playback time. This makes it a great speaker to use at home, outside, or at your desk. Includes a built-in mic, which allows you to take calls through your speaker, a Micro to USB charging cable and 3.5mm audio cable. Packed in an Avenue gift box.

16,5 x 6,5 x 3,7 cm

Compliance: WEEE • Battery Directive • RoHS • R & TTE
Recommended decoration: Padprint



10824800

Avenue

Bluetooth

NIO BLUETOOTH® SPEAKER

ABS plastic.

Outdoor adventures sound better with this water-resistant (IPX4) Bluetooth® speaker. Incl. carabiner for easy hook up to clothes or bags and an integrated audio 3.5mm line cable. Packed in an Avenue gift box.

10 x 9 x 4 cm

Compliance: EMC • WEEE • LVD • MSDS • RoHS • R & TTE
Recommended decoration: Padprint



10821700

Avenue

Bluetooth

NABOO BLUETOOTH® AND NFC SPEAKER

Rubber and metal.

With the Naboo portable speaker, you can enjoy your music anytime and anywhere. The speaker is IP65 certified which guarantees effective splash and dust resistance. The rugged rubberized exterior also provides a superior protection against impact and scratches. Incl. wrist strap so you can always have your speaker at hand. Up to 10 hours continuous music line-in and up to 6 hours Bluetooth on a single charge. The NFC function allows you to pair your NFC enabled device by simply tapping the device to the speaker. Incl. Avenue gift box.

7,6 x 7,6 x 7,5 cm

Compliance: EMC • WEEE • MSDS • RoHS • R & TTE
Recommended decoration: Engraving



10826000

Zoom

Bluetooth

DECIBEL BLUETOOTH® SPEAKER

ABS Plastic.

One speaker, three different color options. The speaker includes 3 different silicone sleeves, Blue, Lime, and Black. You pick the color the Zoom® Audio Decibel will deliver the sound. Bluetooth working range is 10 meters (33 feet). Includes micro USB to USB Charging cable and 3.5mm auxiliary cord.

17 x 7,1 x 7 cm

Compliance: EMC • WEEE • RoHS • R & TTE
Recommended decoration: Padprint

New





10820800



SWERVE BLUETOOTH® AND NFC SPEAKER

ABS Plastic.

At home, the office or on the go, this exclusive design portable Bluetooth® speaker delivers pristine streaming audio when paired with Bluetooth capable devices (10 meters range). The NFC (Near Field Communication) feature allows you to pair your device by simply tapping the device to the speaker. Incl. ifidelity gift box (size: 10,5 x 10 9.6cm).
 ø 7,5 x 7 cm

Compliance: WEEE • Battery Directive • RoHS • R & TTE
 Recommended decoration: Padprint



10818600



SOUNDWAVE BLUETOOTH® SPEAKER

Metal and ABS plastic.

Enjoy music and movies anywhere by pairing your Bluetooth® compatible audio device like iPhone, iPad or Android OS devices, with this easy portable, exclusive design Bluetooth speaker (10 meters range). With the built-in microphone, the Soundwave speaker allows you to conference call on-the-go through your smartphone or by video chat programs like Skype. Includes Micro USB to USB charging cable and 3.5mm Aux Cable in ifidelity gift box.
 17 x 6 x 4,5 cm

Compliance: EMC • WEEE • Battery Directive • RoHS
 Recommended decoration: Padprint



10826200



ROLLBAR BLUETOOTH® SPEAKER STAND

ABS Plastic and Metal.

The ifidelity Rollbar Bluetooth® Speaker Stand offers great sound and functionality. The stand function allows for different viewing angles and offers amplified sound while trying to watch a movie on your tablet or smartphone. Listen to uninterrupted playback via Bluetooth for up to 8 hours. Bluetooth working range 10 meters (33 feet). Micro USB to USB cable included for charging the speaker stand.
 24 x 6 x 4,3 cm

Compliance: EMC • WEEE • RoHS • R & TTE
 Recommended decoration: Engraving



10823000



SIDESWIPE BLUETOOTH® AND NFC SPEAKER

Metal and ABS plastic.

Fitting big sound into a small packing space is easy thanks to this Bluetooth-enabled portable speaker. The two speaker units automatically slide out of their box when switched on, for full stereo effect. To turn off the speaker, just slide back the speakers inside for protective, compact storage. Incl. ifidelity gift box (size: 18.3 x 8.2 x 7.8cm). Exclusive design. 16 x 6,5 x 7 cm

*Compliance: WEEE • Battery Directive • RoHS • R & TTE
Recommended decoration: Padprint*



10821401

10822700

10821402

10821403

10821400

10822701

10822703

10822702



X-MINI ME MONO SPEAKER

ABS Plastic and Silicon.

Superb sound, thumbsize portable X-mini speaker with up to 6 hours playtime. Incl. lanyard, cable organiser and X-mini gift box. Exclusive design. ø 3,8 x 4,4 cm

X-MINI WE BLUETOOTH® AND NFC SPEAKER

ABS Plastic.

Superb sound, thumbsize portable X-mini speaker with Bluetooth and NFC (Near Field Communication) function. The NFC allows you to pair your NFC enabled device by simply tapping the device to the speaker. Up to 5 hours playtime. Incl. lanyard, cable organiser and X-mini gift box. Exclusive design. ø 3,8 x 4,8 cm

*Compliance: WEEE
Recommended decoration: Padprint*

*Compliance: WEEE • Battery Directive • RoHS • R & TTE
Recommended decoration: Padprint*

TECHNICAL CHARTS: SPEAKERS

										
	Speaker Driver	Frequency Response	Playback Time	Output	Battery Capacity*	S/N Ratio	Mic	3.5mm Aux cable	Bluetooth® Version	NFC
10826500-502 Commander Bluetooth® Speaker 	36mm	200Hz - 18kHz	Up to 3 hrs	2W	300mAh	≥85dB	V	V	2.1	-
10816000-004 Naiad Bluetooth® speaker 	36mm	180Hz - 20kHz	Up to 5 hrs	2W	400mAh	≥85dB	-	V	2.1	-
10821500 Triton Bluetooth® speaker 	36mm	20Hz-20kHz	Up to 6 hrs	2W	500mAh	≥85dB	V	V	3.0	-
10826900-901 Kubus Bluetooth and NFC Speaker 	40mm	130Hz - 20kHz	Up to 6 hrs	3W	500mAh	≥90dB	-	V	2.1	V
10822600-602 Jabba Bluetooth® Speaker 	40mm	160Hz - 20kHz	Up to 6 hrs	3W	500mAh	≥85dB	V	V	3.0	-
10826400-402 Greedo Bluetooth® Speaker 	40mm	200Hz - 18kHz	Up to 4 hrs	3W	400mAh	≥90dB	V	V	3.0	-
10826700 Duke Bluetooth® Waterproof Speaker 	45mm	22Hz - 19.8kHz	Up to 4 hrs	3W	400mAh	92dB	V	-	3.0	-
10826800 Lumi Light Up Bluetooth® Speaker 	40mm	200Hz - 20kHz	Up to 4 hrs	3W	600mAh	≥85dB	V	V	2.1	-
10821600-603 Padme Bluetooth® speaker 	40mm	150Hz-18kHz	Up to 4 hrs	2.5W	300mAh	≥80dB	V	V	2.1	-
10824400-403 Nano Bluetooth® Speaker 	40mm	140Hz-20kHz	Up to 4 hrs	2W	280mAh	≥82dB	-	V	3.0	-
10826600 Bran Bluetooth® Powerbank Speaker 	23.8mm	200Hz - 18kHz	Up to 20 hrs	1W	2200mAh	80dB	-	V	2.1	-
10826300 Zabrak Bluetooth® Speaker 	34mm	100Hz-20kHz	Up to 20 hrs	3W	2x2200mAh	85dB	V	V	3.0	V
12359000-9001 Funbox Bluetooth® speaker 	40mm	120Hz-18kHz	Up to 6 hrs	2 x 1.5W	2000mAh	75dB	V	V	2.1	-
10824800 Nio Bluetooth® Speaker 	40mm	100Hz-18kHz	Up to 4 hrs	3W	600mAh	≥80dB	V	V	3.0	-
10821700 Naboo Bluetooth® and NFC Speaker 	50mm	100Hz-18kHz	Up to 10 hrs	5W	2200mAh	94dB	V	V	3.0	V
10826000 Decibel Bluetooth® Speaker 	50mm	150Hz-18kHz	Up to 4 hrs	3W	400mAh	≥70dB	V	V	2.1	-
10820800 Swerve Bluetooth® and NFC Speaker 	38mm	100Hz-18kHz	Up to 3 hrs	2W	700mAh	42dB	V	V	3.0	V
10826200 Rollbar Bluetooth® Speaker stand 	40mm	90Hz-20kHz	Up to 6 hrs	2 x 5W	1050mAh	≥80dB	V	V	4.0	-
10818600 Soundwave Bluetooth® Speaker 	38mm	100Hz-16kHz	Up to 4 hrs	2 x 1.5W	1200mAh	≥60dB	V	V	2.1	-
10823000 Sideswipe Bluetooth® and NFC speaker 	2 x 40mm	100Hz-20kHz	Up to 5 hrs	2 x 5W	1100mAh	85dB	V	V	3.0	V
10823700 Whirl Alarm Clock Radio 	63.5mm	80Hz-12kHz	Up to 3 hrs	2.5W	1050mAh	50dB	-	V	3.0	-
10821400-403 X-mini ME mono speaker 	31mm	200Hz-20kHz	Up to 6 hrs	1.5W	230mAh	≥89dB	-	V	-	-
10822700-703 X-mini WE Bluetooth® and NFC speaker 	31mm	200Hz-20kHz	Up to 6 hrs	1.5W	230mAh	≥80dB	-	V	3.0	V



10801100

Avenue

CLASSIC RADIO WITH TEMPERATURE

Wood.

Classic wooden radio with AM and FM Radio, featuring calendar, thermometer, time and alarm. Operates on batteries (3xAAA) or DC4.5V adapter (both not included). Comes in an Avenue giftbox. 23 x 10 x 10 cm

Compliance: EMC • WEEE • RoHS
Recommended decoration: Padprint



10823700

iFidelity
experience originality

Bluetooth

WHIRL ALARM CLOCK RADIO

Metal and ABS plastic.

The Whirl packs a Bluetooth speaker, dual alarm clock and FM Radio all into one device. Sync to your favorite music via Bluetooth and enjoy wireless music with up to 10 meters from your handheld device. The FM radio can store up to 50 FM stations automatically for easy recall at any time. Features up to 3 hours of playback time. Includes 3.5mm audio cable and AC-DC charging adaptor. Packed in an ifidelity gift box. 21,3 x 12,8 x 9,5 cm

Compliance: WEEE • Battery Directive • RoHS • R & TTE
Recommended decoration: Padprint



New

10827200

Avenue

DAB ALARM CLOCK RADIO

ABS Plastic.

Portable DAB/FM Radio featuring on-screen text information, station presets, auto channel scan, two sounding alarm settings and a built-in FM tuner. Incl. rechargeable built-in battery and headphone input for private listening. Packed in a black gift box. 14,4 x 12,8 x 4,4 cm

Compliance: Battery Directive • RoHS
Recommended decoration: Padprint



10824901

Avenue



10824900



10824902



10820500

Avenue

RAVER HEADPHONES

ABS plastic and PU.

These great value headphones help you get your message heard without overstretching your budget. Foldable design incl. comfortable earpads packed in an Avenue gift box.

14,5 x 6,4 x 17 cm

Compliance: RoHS

Recommended decoration: Padprint

STREETZZ STEREO HEADPHONES

ABS Plastic.

Stereo headphones with extra comfortable earpads providing superior sound to use on the go or at home. The headband can be adjusted for optimum fit. Incl. Avenue gift box.

15,9 x 6,5 x 18 cm

Compliance: WEEE • RoHS

Recommended decoration: Padprint



10825000

Avenue



10818401

Avenue



10818400

DAZZLER HEADPHONES

ABS Plastic.

Fashion style design headphones with soft padded headband for comfort. The different shaped headphones offer an alternative look to listening. Easy to carry by foldable design. Packed in an Avenue gift box.

17 x 8 x 18,5 cm

Compliance: WEEE • RoHS

Recommended decoration: Padprint

CHAOS HEADPHONES

ABS Plastic.

Lightweight foldable headphones with flat noodle cable design and music controller (compatible with both iOS and Android) that allows you to skip songs, adjust volume, and even take calls while using your smartphone, tablet or other audio device. The Chaos headphones feature a padded headband and comfortable over ear cups to ensure long listening sessions. Incl. EVA molded case packed in an Avenue gift box (Size: 21 x 14,5 x 8,5cm).

17 x 7 x 17 cm

Compliance: EMC • WEEE • RoHS

Recommended decoration: Padprint

Avenue

HIPSTERZ HEADPHONES

ABS Plastic and Metal.

These exclusive design trendy headphones with extra large earcups are an absolute fashionable hit. Packed in an Avenue gift box.
17,5 x 8 x 17 cm

Compliance: WEEE • RoHS
Recommended decoration: Padprint



New

10825600



Avenue

Bluetooth®

RHEA BLUETOOTH® HEADPHONES

ABS Plastic.

Stream music from your Bluetooth® enabled devices with the Rhea Bluetooth® over-the-ear headphones. The Rhea delivers clear vocal sound and deep powerfull bass. Bluetooth® working range is 10 meters and the built-in lithium battery will continously play music for up to 8 hours. Packed in an Avenue gift box.
19 x 18 x 7,5 cm

Compliance: WEEE • Battery Directive • RoHS • R & TTE
Recommended decoration: Padprint

Avenue

Bluetooth®

ENYO BLUETOOTH® HEADPHONES

ABS Plastic.

Stream music from your Bluetooth® enabled devices with these comfortable stereo quality over-ear foldable headphones giving you the freedom of wireless music (up to 10 metres) without compromise. The built-in mic allows you to easily switch between music and calls. The Enyo headphones includes a built-in microphone, 3,5mm audio input and adjustable headband.
Incl. Avenue gift box.
18,5 x 8,5 x 18,5 cm

Compliance: WEEE • Battery Directive • LVD • RoHS • R & TTE
Recommended decoration: Padprint





Avenue

MIDAS TOUCH BLUETOOTH® HEADPHONES

ABS Plastic.

Who needs buttons when you have a touch screen? With the simple touch of your finger onto the earpiece you can control your music. When connected via Bluetooth® you can enjoy up to 12 hours of playback time. Includes micro usb to USB charging cable and auxiliary cord. Bluetooth® working range is 10 meters.

Recommended decoration: Padprint

Avenue



CRONUS BLUETOOTH® HEADPHONES

Aluminium, Plastic and PU.

Stream music from your Bluetooth® enabled devices with the comfortable stereo quality over-ear headphones. These high quality foldable headphones will work within 10 meters of your device. The built-in lithium battery will continuously play music for up to 10 hours and requires only 2.5 hours to fully recharge. The built-in microphone and controls on the headphones allow you to answer calls without taking your smartphone out of your pocket. Incl. Avenue gift box.

13,2 x 6,5 x 17 cm



Compliance: WEEE • Battery Directive • MSDS • RoHS • R & TTE

Recommended decoration: Padprint

MIRAGE HEADPHONES

ABS Plastic.

Exclusive design foldable headphones delivering pristine sound quality. The built-in music controller allows you to adjust volume, songs and take incoming calls (limited functionality on non iOS devices). Incl. EVA molded carrying case and packed in an ifidelity gift box (size: 23,2 x 16,5 x 9,5 cm). 17,5 x 8 x 18 cm

Compliance: WEEE • RoHS
Recommended decoration: Padprint



10820400

PROWL NOISE REDUCTION HEADPHONES

ABS plastic.

Exclusive design foldable noise reduction headphones delivering pristine sound quality. Ideal for the frequent traveller and commuter. Operates on 2x AAA battery (included). Carrying pouch and airline adaptor included. Packed in an ifidelity gift box. 19 x 8 x 18,5 cm

Compliance: WEEE • Battery Directive • RoHS • R & TTE
Recommended decoration: Padprint



10824100



OPTIMUS BLUETOOTH® HEADPHONES

ABS Plastic and Metal.

These exclusive design foldable wireless headphones bring an off-the-wall look to musical expression. The Optimus headphones allow you to stream music from your Bluetooth® enabled device (10 metres range) giving you the freedom of wireless music without compromise. The built-in microphone and controls on the headphones allow you to answer calls and control your music without taking your smartphone out of your pocket. Incl. ifidelity gift box (23,3 x 16,7 x 10.1cm). 20 x 8,5 x 18,5 cm

Compliance: WEEE • Battery Directive • RoHS • R & TTE
Recommended decoration: Padprint



10822900

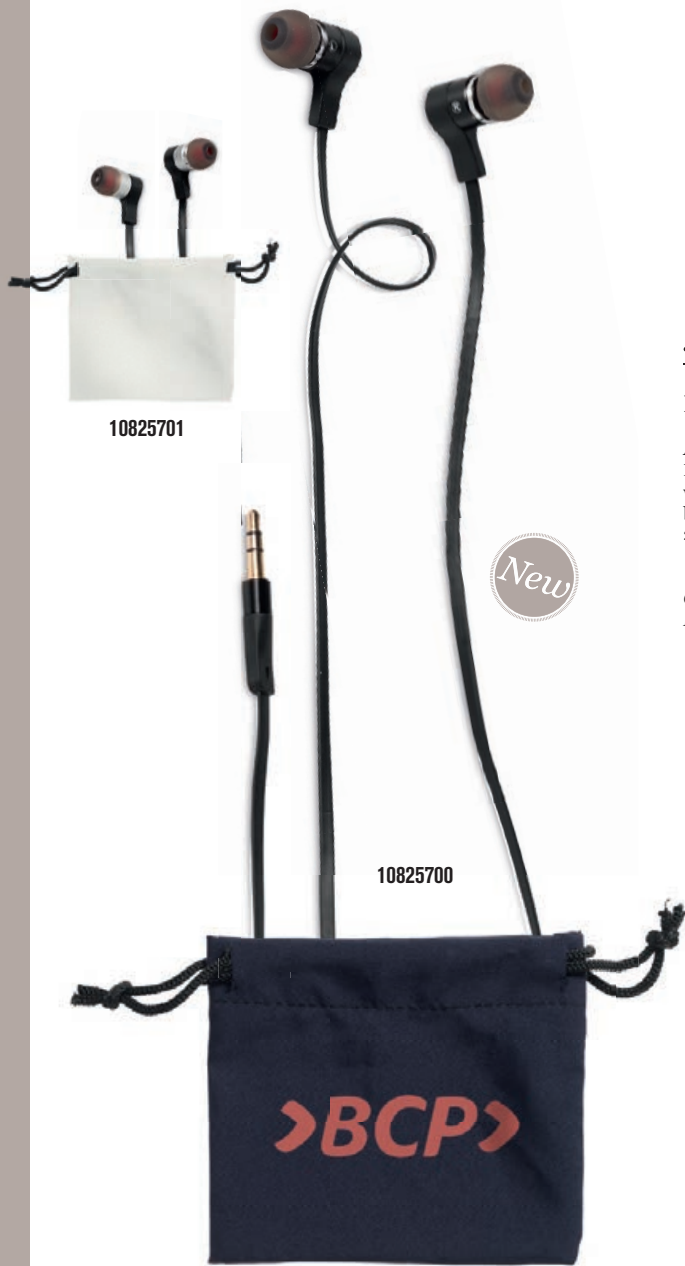

10825701

10825700

New

Avenue

FLARE EARBUDS

Metal.

The Flare lightweight metal earbuds are the perfect companion for your smartphone, tablet or other audio device, delivering incredible sound and maximum comfort. Incl. carrying pouch, packed in an Avenue gift box. ø 1,2 cm

Compliance: WEEE • RoHS
Recommended decoration: Screenprint



10820301

10820300

Avenue

FUSION EARBUDS

ABS Plastic.

Flat cabled ear buds with cable control (answer/ end phone calls) compatible with both iOS and Android devices. Incl. pouch and packed in Avenue gift box (8,8 x 8,8 x 4cm). 2,3 x 3,7 cm

Compliance: WEEE • RoHS • Cadmium tested
Recommended decoration: Screenprint



10824600

Avenue

ARMOR SPORT EARBUDS

ABS Plastic.

Designed to stay snugly in your ears even when you're highly active, these non-slip waterresistant (IPX5) earbuds are ideal for use when running or working out. Incl. answering mic to pick up telephone calls and carrying pouch. Packed in an Avenue gift box(8,8 x 8,8 x 4cm). 8 x 3,5 cm

Compliance: WEEE • RoHS
Recommended decoration: Screenprint



Avenue

NEREUS EARBUDS

ABS Plastic.

Comfortable lightweight detachable earhooks ideal for working out or running. Incl. pouch, 2 pair decoration rings and 2 pair silicon earcushions in Avenue gift box(8,3 x 8,3 x 3.8cm). 4 x 5,5 cm

*Compliance: WEEE • RoHS • Cadmium tested
Recommended decoration: Doming*



Avenue

BUZZ BLUETOOTH® EARBUDS

ABS Plastic.

Lose the wire but keep the sound quality of your favorite earbuds. The Buzz Bluetooth® earbuds connect wirelessly to any compatible device up to 33 feet. The flexible ear hooks make these earbuds perfect for working out. Plus they feature a built in control function which allows you to take calls and control the music. Bluetooth® working range is 10 meters (33 feet).





10824500



SILVERBLAST EARBUDS

Metal.

These exclusive design small metal earbuds with their own carrying pouch deliver quality sound for a price that's music to your ears. Packed in an ifidelity gift box (size: 10.8 x 10.8 x 5.7cm).
9 x 7 x 2 cm

Compliance: WEEE • RoHS

Recommended decoration: Padprint



10818700



JAZZ EARPHONES

Metal.

Exclusive design earbuds with milled aluminum housing delivering pristine sound quality. The built in music controller allows you to adjust volume, songs and take incoming calls (limited functionality on non iOS devices). Incl. EVA molded carrying case and packed in an ifidelity gift box (size: 8,3 x 8,3 x 8,3cm).
1 x 2,2 cm

Compliance: EMC • WEEE • RoHS

Recommended decoration: Padprint



10824000



BLURR BLUETOOTH® EARBUDS

ABS Plastic.





Without any trailing cables to deal with, the exclusive design Bluetooth earbuds provide freedom and flexibility. The built-in music controller allows you to adjust volume, control songs and take incoming calls. Incl. removable earhooks and EVA molded carrying case. Bluetooth range 10 metres and up to 6 hours playtime. Packed in an ifidelity gift box (size: 9 x 9 x 8cm).
6,5 x 6,5 cm



















Compliance: WEEE • Battery Directive • RoHS • R & TTE

Recommended decoration: Padprint

**TECHNICAL CHARTS:
HEADPHONES
AND EARBUDS**

												
	Driver Diameter	Frequency Response	Impedance	Sensitivity	Rated Power	Maximum Output	Answering Mic	Volume control	Detachable Audiocable	Foldable	Noise Reduction	Case/Pouch
10824900-902 Raver headphones 	40mm	20Hz-20kHz	32 ohm	108dB	10mW	20mW	V	-	V	V	-	-
10820500 Streetz stereo headphones 	40mm	20Hz-20kHz	32 ohm	114dB	25mW	100mW	-	-	-	-	-	-
10818400-401 Chaos Headphones 	40mm	20Hz-20kHz	32 ohm	118dB	5mW	10mW	V	V	-	V	-	V
10825000 Dazzler Headphones 	30mm	20Hz-20kHz	32 ohm	105dB	5mW	10mW	-	-	V	V	-	-
10823900 Hipsterz Headphones 	40mm	20Hz-20kHz	32 ohm	100dB	20mW	10mW	V	V	-	-	-	-
10824100 Prowl Noise Reduction Headphones 	40mm	20Hz-20kHz	32 ohm	108dB	25mW	100mW	-	-	-	V	V	V
10820400 Mirage headphones 	40mm	20Hz-20kHz	32 ohm	100dB	20mW	50mW	V	V	-	-	-	V

									
	Driver Diameter	Frequency Response	Impedance	Sensitivity	Rated Power	Maximum Output	Answering Mic	Volume control	Case/Pouch
10825700-701 Flare Earbuds 	10mm	20Hz-20kHz	16 ohm	102dB	10mW	30mW	-	-	V
10820300-301 Fusion Earbuds 	14.2mm	20Hz-20kHz	22 ohm	104dB	2mW	5mW	V	V	V
10824600 Armor Sport Earbuds 	10mm	20Hz-20kHz	24 ohm	101db	5mW	10mW	V	-	V
10820700 Nereus earbuds 	10mm	20Hz-20kHz	16 ohm	104dB	3mW	60mW	-	-	V
10824500 Silverblast Earbuds 	9mm	20Hz-20kHz	16 ohm	101db	3mW	5mW	V	-	V
10818700 Jazz earphones 	8mm	20Hz-20kHz	16 ohm	96dB	2mW	5mW	V	V	V

												
	Driver Diameter	Frequency Response	Impedance	Sensitivity	Rated Power	Maximum Output	Playback Time	Answering Mic	Volume control	Foldable	Case/Pouch	Bluetooth® Version
10825600 Rhea Bluetooth® Headphones 	40mm	20Hz-20kHz	32 ohm	110dB	20mW	50mW	Up to 10 hrs	V	V	V	-	4.0
10822800 Enyo Bluetooth® headphones 	40mm	20Hz-20kHz	32 ohm	106dB	15mW	30mW	Up to 10 hrs	V	V	V	-	3.0
10820900 Cronus Bluetooth® headphones 	40mm	20Hz-20kHz	32 ohm	110dB	10mW	30mW	Up to 12 hrs	V	V	V	-	3.0
10825800 Midas Touch Bluetooth® Headphones 	40mm	20Hz-20kHz	32 ohm	105dB	40mW	50mW	Up to 12 hrs	V	V	V	-	4.0
10822900 Optimus Bluetooth® Headphones 	40mm	20Hz-20kHz	32 ohm	116dB	10mW	50mW	Up to 10 hrs	V	V	V	V	4.0
10827000 Buzz Bluetooth® Earbuds 	10mm	20Hz-20kHz	16 ohm	105dB	10mW	30mW	Up to 3 hrs	V	V	-	V	4.1
10824000 Blurr Bluetooth® Earbuds 	10mm	150Hz-20kHz	16 ohm	83db	10mW	15mW	Up to 6 hrs	V	V	-	V	4.0

Avenue

PB-2200 STINGER POWERBANK

ABS Plastic and Silicone.

The Stinger powerbank with 2200mAh is the perfect charger on the go. Thanks to the suction cups it sticks right onto the back of your smartphone for easy and quick charging (5V/1A output). Incl. "automatic sleep" function to reduce loss of power while not in use, 3 LED indicator lights and USB to Micro USB charging cable. Packed in and Avenue gift box. Exclusive design. 9 x 6 x 0,7 cm

Compliance: EMC • WEEE • Battery Directive • RoHS

Recommended decoration: Padprint



12362000

New



12358702

12358701



12358700



12361000

12361001

New

Avenue

PB-3000 POWERBANK

ABS Plastic.

Powerbanks are an indispensable item for on-the-go people. This 3000mAh powerbank has an integrated USB/ Micro-USB cable and is compatible with most smartphones. Can be charged via the USB port of a laptop or computer. Packed in an Avenue gift box (size: 18,5 x 4,5 x 2,5cm). 13 x 4 x 1,2 cm

Compliance: EMC • WEEE • Battery Directive • MSDS • RoHS

Recommended decoration: Padprint

Avenue

PB-4000 FARAD CHARGER

Metal.

Pocket size 4400mAh metal powerbank with 5V/1A output incl. LED indicator compatible with most smartphones, tablets and USB powered devices. Can be charged via the USB port of a laptop or computer. Incl. micro USB charging cable and packed in an Avenue gift box. 9,3 x 4,5 x 2,2 cm

Compliance: EMC • WEEE • Battery Directive • RoHS

Recommended decoration: Padprint



12358800

Avenue

PB-6600 VAULT CHARGER

ABS Plastic.

High mAh at a valuable price. The Vault Charger packs 6600 mAh and a dual output with the first port at 5V/1A and the second port at 5V/2A. An LED flashlight is incorporated into the end of the style. The power button will turn the powerbank on and off as well as indicate how much power is left. The device will hibernate into automatic sleep mode to reduce power loss. Includes a USB to micro USB charging cable. Packed in an Avenue gift box. 9,5 x 6,3 x 1,9 cm

*Compliance: EMC • WEEE • Battery Directive • RoHS
Recommended decoration: Padprint*



12354200

Avenue

PB-6000 GIGA CHARGER

ABS Plastic.

The Giga charger packs 6,000 mAh with a dual output of 5V/2A. The LED digital power indicator will confirm exactly how much charge remains within the power bank. Its compact design makes it easy to carry wherever you go. The dual USB outputs are perfect for simultaneously charging both your tablet and smartphone. Includes a USB to Micro USB charging cable which can recharge the power bank or can be used to charge up devices with a Micro USB input like Android Smartphones from Samsung, Motorola, HTC, Nokia and others. Incl. Avenue gift box. 7,5 x 7,5 x 2,2 cm

*Compliance: EMC • WEEE • Battery Directive • RoHS
Recommended decoration: Padprint*



12356400

Avenue

SC1500 SOLAR CHARGER GIFT SET

ABS plastic.

Portable lightweight 1500mAh solar charger incl. LED indicators for charging smartphones and other USB powered devices. The LED indicators show how much capacity is still inside the charger. The charger can be charged through sunlight or via the USB port of your laptop. Incl. rechargeable battery, pouch and packed in an Avenue gift box (size: 12,7 x 10,5 x 3,3cm). 11,5 x 5 x 1,2 cm

*Compliance: WEEE • Battery Directive • MSDS • RoHS
Recommended decoration: Padprint*

Avenue

PB-4000 BASK SOLAR POWERBANK

ABS Plastic.

The Bask Solar Power Bank is ideal for any camping trip or day at the beach. This 4,000mAh 5V/1A output power bank can be charged by the sun or the included USB to Micro USB connecting cable that can also be used to charge devices with a Micro USB input.

12,5 x 7,8 x 1,3 cm

Compliance: EMC • WEEE • Battery Directive • RoHS
Recommended decoration: Padprint



Avenue

PB-4400 POWERBANK

ABS plastic.

Pocket size 4400mAh powerbank incl. LED indicator compatible with most smartphones, tablets and USB powered devices. Can be charged via the USB port of a laptop or computer. Packed in an Avenue gift box (size: 8.3 x 8.3 x 3.6cm).

7,2 x 5,2 x 2,2 cm

Compliance: EMC • WEEE • Battery Directive • MSDS • RoHS
Recommended decoration: Screenprint



Avenue

PB-5000 POWERBANK

ABS Plastic.

This 5000 mAh powerbank with double USB output (5V/2.1A and 5V/1A) gives you extra power when needed. Incl. 5 LED indicators showing power level. USB input and Micro USB output cables are integrated. Compatible with most smartphones, tablets and other USB powered devices. Can be charged via the USB port of a laptop or computer. Incl. rechargeable battery and Avenue gift box (size: 12.5 x 7.6 x 3cm).

11 x 6,5 x 1,7 cm

Compliance: EMC • WEEE • Battery Directive • MSDS • RoHS
Recommended decoration: Padprint



12357500



12366000



Avenue

Avenue

PB-10200 POWERBANK

ABS plastic.

This 10200 mAh powerbank with double USB output (5V/2.1A and 5V/1A) gives you extra power when needed. Incl. LED indicators showing power level. USB input and Micro USB output cables are integrated. Compatible with most smartphones, tablets and other USB powered devices. Can be charged via the USB port of a laptop or computer. Incl. rechargeable battery and Avenue gift box (size: 14.5 x 7.7 x 3cm).
13,3 x 6,7 x 1,4 cm

Compliance: EMC • Battery Directive
Recommended decoration: Padprint

PB-20000 MEGA CHARGER

ABS Plastic.

This 20000 mAh powerbank with 4 outputs (2x 5v2.4a and 2x 5v1a) gives you extra power when needed. Incl. LED indicators showing power level and integrated USB input and Micro USB output cables. Compatible with most smartphones, tablets and other USB powered devices. Can be charged via the USB port of a laptop or computer. Incl. flashlight function and packed in a black gift box.
15,8 x 7,75 x 1,86 cm

Compliance: EMC • WEEE • Battery Directive • RoHS
Recommended decoration: Padprint

New



12357700

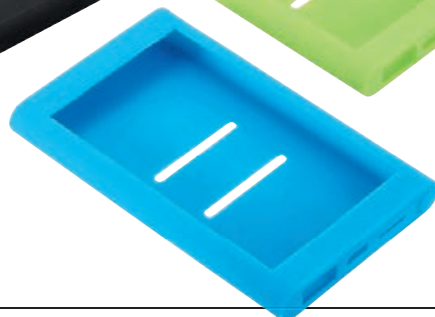
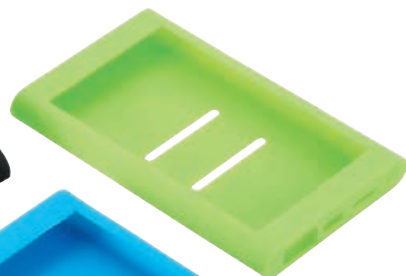

Avenue

PB-4000 ZOOM ENERGY TORUS

Metal and Silicone.

The Zoom® Energy Torus allows you to customize your power bank. This set includes a Black, Lime and Turquoise silicone cases to match your personality or mood. This 5V/1A 4000mAh Lithium Polymer battery backup will charge your smartphone at the same rate as a wall charger. The slits on the back of the silicone case double as cable storage. match your personality or mood. This 5V/1A 4000mAh Lithium Polymer battery backup will charge your smartphone at the same rate as a wall charger. Includes a USB to Micro USB charging cable which can charge the battery backup or charge up devices with a Micro USB input.
12 x 6,7 x 1 cm

Compliance: EMC • WEEE • Battery Directive
Recommended decoration: Padprint

New



12354300

Zoom

PB-4000 ANODE POWER CHARGER

Abs plastic.

The Zoom Power Anode offers the perfect solution for power as it incorporates both a power bank and AC adaptor into one piece. Simply open the prongs and use the style as an AC adaptor. The Anode will charge itself while plugged into a wall outlet. Unplug with a full charge and the Anode will act as a power device with 4400mAh at 5V/1A. Power Supply can be monitored by pressing the power button when charger is plugged into a device or at rest. Incl. cable wrap and packed in an Avenue gift box. 7,5 x 7,5 x 4 cm

Compliance: EMC • WEEE • Battery Directive • RoHS
Recommended decoration: Padprint



12347601



12347600

Zoom

PB-5600 POWERBANK

ABS Plastic.

Exclusive design energy box with integrated Micro-USB and USB cables to charge two items simultaneously. Simply slide the cover and pull out the cables. Features: 5600mAh Li-on Battery with total output current up to 2A. Compatible with most smartphones, tablets and other USB-powered devices. Can be charged via the USB port of a laptop or computer. Incl. transparent Zoom gift box (size: 11 x 8 x 3.1cm). 8,6 x 5,8 x 2,4 cm

Compliance: EMC • WEEE • Battery Directive • MSDS • RoHS
Recommended decoration: Padprint

Zoom

PB-8800 ENERGY SNAP POWERBANK

ABS Plastic.

Tired of misplacing your cables. Well look no further, the Zoom™ Energy Snap packs 8,800 mAh, 5v/3.1A total output and a magnetic storage compartment to store your cables. Other highlights include the dual USB sockets for simultaneous charging which is perfect for charging your smartphone and tablet at the same time, a sliding switch, and an LED power check indicator. Includes a Micro USB to USB charging cable which can be used to charge the power bank or can be used to charge up devices with a Micro USB input. 12,2 x 2,3 x 7,3 cm

Recommended decoration: Screenprint

New



12358900

**TECHNICAL CHARTS:
POWERBANKS**

							
	Capacity (mAh)	Battery Type	Output	Charging 2 items simultaneously	Indicator Powerlevel	Integrated Cables	Compatibility
12362000 PB-2200 Stinger Powerbank 	2200mAh	Lithium Polymer	5V/1A	-	V	-	Smartphone
12358700-702 PB-3000 Powerbank 	3000 mAh	Lithium Polymer	5V/1A	-	-	V	Smartphone
12361000-001 PB-4000 Farad Charger 	4000mAh	Lithium-ion	5V/1A	-	V	-	Smartphone/Tablet/Navigation/ Speaker/Other USB devices
12354200 PB-6000 Giga Charger 	6000mAh	Lithium-ion	1: 5V/1A 2: 5V/2A	V	V	-	Smartphone/Tablet/Navigation/ Speaker/Other USB devices
12358800 PB-6600 Vault Charger 	6600mAh	Lithium-ion	1: 5V/1A 2: 5V/2A	V	V	-	Smartphone/Tablet/Navigation/ Speaker/Other USB devices
12356400 SC1500 Solar charger gift set 	1500mAh	Lithium-ion	5V/1A	-	V	-	Smartphone
12360100 PB-4000 Bask Solar Powerbank 	4000mAh	Lithium Polymer	5V/1A	-	V	-	Smartphone/Tablet/Navigation/ Speaker/Other USB devices
12356500-505 PB-4400 powerbank 	4400 mAh	Lithium-ion	5V/2A	-	V	-	Smartphone/Tablet/Navigation/ Speaker/Other USB devices
12347100 PB-5000 powerbank 	5000mAh	Lithium Polymer	1: 5V/1A 2: 5V/2A	V	V	V	Smartphone/Tablet/Navigation/ Speaker/Other USB devices
12357500 PB-10200 Powerbank 	10200mAh	Lithium Polymer	1: 5V/1A 2: 5V/2.1A	V	V	V	Smartphone/Tablet/Navigation/ Speaker/Other USB devices
12366000 PB-20000 Mega Charger 	20000mAh	Lithium Polymer	1& 2: 5V/2.4A 3 & 4: 5V/1A	V	V	V	Smartphone/Tablet/Navigation/ Speaker/Other USB devices
12357700 PB-4000 Zoom Energy Torus 	4000mAh	Lithium Polymer	5V/1A	-	V	-	Smartphone/Tablet/Navigation/ Speaker/Other USB devices
12354300 PB-4000 Anode Power Charger 	4000mAh	Lithium-ion	5V/2A	-	V	-	Smartphone/Tablet/Navigation/ Speaker/Other USB devices
12347600 PB-5600 powerbank 	5600mAh	Lithium-ion	1: 5V/1A 2: 5V/2.1A	V	V	V	Smartphone/Tablet/Navigation/ Speaker/Other USB devices
12358900 PB-8800 Energy Snap Powerbank 	8800mAh	Lithium-ion	1: 5V/1A 2: 5V/2A	V	V	V	Smartphone/Tablet/Navigation/ Speaker/Other USB devices



12363000

Avenue

MFI LIGHTNING CABLE

ABS Plastic.

The MFI Certified Lightning Cable is a great add on to any of our chargers. This adaptor will charge an iPad mini, iPad Air and iPhone 5, 5S, 5C, 6 and 6 Plus. Sold Blank Only.
100 cm

Compliance: WEEE • RoHS
Recommended decoration: Padprint

New



13417600

Avenue

MFI CERTIFIED BEETLE CHARGING CABLES

EVA.

Zippered travel case includes 2 USB cables for charging and/or syncing Apple® devices/most Android devices. Cables are MFI certified. One cable with micro USB connector and one with 8-pin lightning connector. Cable length is 100 cm.
ø 8,3 x 3,5 cm

Compliance: WEEE • RoHS
Recommended decoration: Screenprint



12366100

Avenue

MFI CERTIFIED 3-IN-1 CABLE

ABS Plastic.

The perfect charging cable for all your charging needs. The MFI Certified 3-in-1 Cable comes in a convenient clear plastic carrying case perfect for making sure your cable does not get tangled. This cable includes a 30 pin, Lightning and Micro USB connectors that can connect to smartphones and tablets like iPhone, iPad, and Android based tablets and smartphones from Samsung, HTC, Motorola, and others.
ø 1,5 x 0,15 x 5,5 x 10,5 cm

New



Made for
 iPod  iPhone  iPad



13419701

Avenue

VOLT POWER KIT WITH MFI 3-IN-1 CABLE

EVA Case.

Never worry about carrying multiple cables again. The Volt Power Kit includes a MFI Certified 3-in-1 charging cable with integrated Lightning, 30-pin and Micro USB adaptors, a 2200mAh Volt Power Bank and a molded carrying case ideal for traveling.

11,1 x 8,3 x 4,4 cm

Compliance: EMC • WEEE • Battery Directive • MSDS • RoHS
 Recommended decoration: Screenprint



12365000

Avenue

POWERTECH USB HUB

ABS Plastic.

Charge up to 6 USB-powered devices at the same time with the Powertech USB hub. Perfect for home use or travel. The total output of the hub is 4.2A. Charging power (per side) when charging one device: 2.1A, two devices: 1.05A/1.05A and three devices: 0.7A/0.7A/0.7A. The input is 110-240V AC (detachable AC cord included). The blue LED power indicator-lights indicate the charge status per device. Packed in an Avenue gift box.

8,8 x 6 x 2,4 cm

Compliance: EMC • WEEE • RoHS
 Recommended decoration: Padprint



12343900

Avenue



SHIRA BLUETOOTH® KEYBOARD

Plastic with silicone keys.

Sleek and compact foldable Bluetooth keyboard ideal for anyone who use their tablet or smartphone for writing documents or making notes. Effective working range is 10m from the Bluetooth device. Incl. micro USB charging cable, carrying pouch and Avenue gift box (size: 15,8 x 11,1 x 4cm).

13 x 2,3 x 9,1 cm

Compliance: EMC • WEEE • Battery Directive • LVD • MSDS • RoHS • R & TTE

Recommended decoration: Padprint



Fisheye



Wide angle



Macro

Avenue

PRISMA SMARTPHONE LENS SET

Metal and ABS plastic.

Make your smartphone photography more creative with this set of easy-to-use special-effect lenses. Simply clip over the lens on your smartphone to take pictures with fisheye, wide-angle and macro effects. Have fun seeing the world a little differently! Packed in Avenue gift box (size: 8.5 x 8.5 x 3.5cm). 8 x 8 x 3 cm

*Compliance: Cadmium tested
Recommended decoration: Screenprint*



12356600

SMARTPHONE, TABLET AND LAPTOP CASES

BY AVENUE



Avenue

iPad MINI SLEEVE

Neoprene.

Thick durable exclusive design neoprene sleeve protect your iPad Mini or 7" Tablets. The zipper closure ensures your Tablet is safe inside the faux fur lining which is surrounding your Tablet on the interior of the sleeve. The Zoom "Access Tab" allows you to charge your device while still in the safety sleeve. Packed in an Avenue gift pouch. Tablet and accessoires not included. 13,5 x 1,6 x 21 cm

Compliance: Cadmium tested
Recommended decoration: Transfer



11988100



12356300



11984600

Avenue

KERIO iPad AIR CASE

PVC and polycarbonate.

This slim iPad Air case folds open to give multiple landscape viewing or working positions. The back features a stylus loop and anti-slip material that helps ensure your iPad Air will not slip off a desk, table, or out of your hand while working with it. The back also is a polycarbonate shell protecting your iPad from dents and scratches. Incl. Avenue gift box. 24,4 x 17,2 x 1,5 cm

Compliance: Cadmium tested
Recommended decoration: Screenprint

Avenue

LEATHER TABLET MINI SLEEVE

Split leather.

Exclusive design tablet mini sleeve with easy out system. By pulling the strap your up to 7" tablet instantly slides out of your case. With snap button closure. Packed in a gift box. Tablet not included. 21,5 x 15,2 x 1 cm

Compliance: AZO • Formaldehyde • PCP • Cadmium tested
Recommended decoration: Screenprint

Avenue

LEATHER TABLET SLEEVE

Split leather.

Exclusive design tablet sleeve with easy out system. By pulling the strap your up to 10" tablet instantly slides out of your case. With snap button closure. Packed in a gift box. Tablet not included.
20 x 25 cm

Compliance: AZO • Formaldehyde • PCP • Cadmium tested
Recommended decoration: Screenprint



11984500



11983500



11983600

MARKS  AN

HORIZON MINI TABLET SLEEVE

300D High density polyester.

Exclusive designed padded laptop sleeve with magnetic closure. Soft lining that protects your tablet from scratches. Suitable for 8" tablets. Packed in a Marksman gift box. Tablet not included.
16 x 21,5 cm

Compliance: Cadmium tested
Recommended decoration: Transfer

MARKS  AN

HORIZON TABLET SLEEVE

300D High density polyester.

Exclusive design tablet sleeve. Protect your up to 10" tablet with this padded sleeve with blue lining and unique buckle closure that secures your tablet. Packed in a Marksman gift box. Tablet not included.
21 x 26 cm

Recommended decoration: Transfer



11989400



11985200

MARKS  AN

MARKS  AN

ODYSSEY SMARTPHONE WALLET

Tarpaulin.

Exclusive design smartphone wallet with three card sleeves. Packed in a Marksman gift box. Accessoires not included.
8,1 x 12,6 cm

*Compliance: Cadmium tested
Recommended decoration: Screenprint*

ODYSSEY iPhone 5/5S/5C SLEEVE

Tarpaulin.

Exclusive design phone pouch with soft nylex lining that protects your phone from scratches. The pouch has a front pocket to store creditcards. Packed in a Marksman gift box. Phone not included.
7,6 x 13 cm

*Compliance: Cadmium tested
Recommended decoration: Screenprint*



MARKS  AN

ODYSSEY MINI TABLET SLEEVE

Tarpaulin.

Exclusive designed padded tablet sleeve with magnetic closure. Soft nylex black lining that protects your tablet from scratches. Suitable for 8" tablets. Packed in a Marksman gift box. Tablet not included.
15,4 x 22 cm

*Compliance: Cadmium tested
Recommended decoration: Screenprint*



11983800



11971800

MARKS M AN

ODYSSEY TABLET SLEEVE

Tarpaulin.

Exclusive design sleeve, protects up to a 10" tablet from scratches and smudges. Packed in a Marksman gift box. Tablet not included. 21 x 25,5 cm

Compliance: Cadmium tested

Recommended decoration: Screenprint



11996200

MARKS M AN

ODYSSEY MINI TABLET ORGANIZER

Tarpaulin.

Exclusive design tablet sleeve that can be used as a stand, with several pockets and holders to store your cards, papers pens and stylo's. Suitable for 8" tablets. Packed in a Marksman gift box. Tablet and accessoires not included.

16,5 x 23 cm

Compliance: Cadmium tested

Recommended decoration: Screenprint





10" TABLET SLEEVE

300D Polyester.

This universal sleeve houses a wide variety of 9-10" tablets, with or without a folio or Smartcover™, and provides a pocket for must-have accessories such as earphones and a charger. Keep it all together while looking sharp with this innovative, versatile sleeve.

21 x 4,5 x 1,7 cm

Recommended decoration: Transfer



12010200



12.1" CHROMEBOOKS™ SLEEVE

Neoprene.

Compact neoprene sleeve allows you to safely transport your netbook alone or in any briefcase, messenger bag or backpack. Compatible with Chromebook™ or Ultrabook™ with up to 12.1" screens. Outer zippered accessory pocket provides a convenient place to carry your power adapter, cables and accessories. Carry handles for comfortable transportation. 31,5 x 3,8 x 23,8 cm

Recommended decoration: Screenprint



12007600



13" LAPTOP SLEEVE

300D Polyester.

This streamlined sleeve houses a 13" laptop and front zipper pocket fits an iPad®/10.1" tablet or can double as storage for accessories and earbuds. Dual density foam padding cushions the exterior and prevents internal scratching. Compact design allows this case to fit easily into any bag.

37,5 x 3 x 26,9 cm

Recommended decoration: Transfer



12007700

BAGS
BY AVENUE



YOSEMITE



11992400

Avenue

YOSEMITE LARGE TOTE

900D Polyester.

Double handled tote with zippered main compartment and small zipper pocket inside the main compartment.
44 x 13 x 30 cm

Compliance: Cadmium tested

Recommended decoration: Screenprint

11992700



Avenue

YOSEMITE 15,6" LAPTOP CONFERENCE BAG

900D Polyester.

Double handled laptop bag with padded laptop compartment, 4 inside organisation pockets, inside zipper pocket, front zipper pocket and adjustable removable padded shoulder strap.

32 x 4 x 24 cm

Compliance: Cadmium tested
Recommended decoration: Screenprint

11992600



Avenue

YOSEMITE 10" TABLET SHOULDER BAG

900D Polyester.

Shoulder bag with front zipper pocket, inside main compartment a zipper pocket and a padded 10" tablet compartment. Including an adjustable shoulder strap.

24 x 5 x 32 cm

Compliance: Cadmium tested
Recommended decoration: Screenprint

Avenue's
Favourites

11992500



Avenue

YOSEMITE CONFERENCE BAG

900D Polyester.

Double handled document bag with zippered main compartment and small zipper pocket inside the main compartment.

34 x 2,5 x 25 cm

Compliance: Cadmium tested
Recommended decoration: Screenprint

11992800



Avenue

YOSEMITE 15,6" LAPTOP BACKPACK

900D Polyester.

This 15,4" laptop bag has an internal organisation panel inside the main zippered compartment and a front zippered compartment.

30 x 15 x 43 cm

Compliance: Cadmium tested
Recommended decoration: Screenprint



11992900

Avenue

YOSEMITE TRAVEL BAG

900D Polyester.

Travel bag has a zippered main compartment, inside zipper pocket and adjustable shoulder strap.

45 x 24 x 30 cm

Compliance: Cadmium tested
Recommended decoration: Screenprint

New



12014100

Avenue

STARK TECH TABLET MESSENGER BAG

600D Polyester.

This exclusive design includes integrated features to keep you powered up on the go. The zippered main compartment has a padded tablet sleeve which fits 10" tablets, a spacious compartment to store books and files and a power bank pocket. The smart pass-through port in the main compartment connects to the front of the bag under flap. The front pocket under the flap fits most power banks making it possible to charge all your mobile devices without having to remove them from the bag. The elastic organizer strap under flap allows you to store small cables.

22 x 7,5 x 28 cm

Compliance: Cadmium tested

Recommended decoration: Screenprint

Avenue

STARK TECH 15.6" LAPTOP BACKPACK

600D Polyester.

Exclusive design backpack with integrated features to keep you powered up and on the move. The zippered main compartment has a padded laptop sleeve which fits up to a 15.6" laptop, elastic organizer band to hold your mobile accessories. The smart pass-through port in the front wall allows your cables to run from the main compartment, where your power source is located, to the front organizer pocket to charge your tablet or phone while on the go. The zippered front compartment has a dedicated padded tablet sleeve, phone pocket and full organization panel. An earbud port on the front panel allows your headphone cable to connect to your mobile devices.

39 x 12 x 45 cm

Compliance: Cadmium tested

Recommended decoration: Screenprint

Avenue's
Favourites

New



12013800

New



12014000

Avenue

STARK TECH 15,6" LAPTOP SHOULDER BAG

600D Polyester.

This exclusively designed bag includes integrated features to keep you powered in your day to day commute. The zippered main compartment has a padded laptop sleeve which fits most 15.6" laptops, a padded tablet sleeve and a large open compartment for files and binders. The dedicated power bank pocket has a smart pass-through port that allows you to connect your power cord to your tablet or laptop. The organization panel also has a smart pass through port to connect your cable to the main compartment where your mobile devices are located without having to remove your power bank. The zippered side pocket has an earbud port.

40 x 7,5 x 30 cm

Compliance: Cadmium tested

Recommended decoration: Screenprint

STARK TECH



12018000

Avenue

STARK TECH DUFFEL

600D Polyester.

This exclusive design travel bag includes integrated features to keep you powered up on the go. The large zippered main compartment includes a padded laptop sleeve that will fit most 15,6" laptops. The smart pass-through port between the main compartment and the organizer pocket allows you to connect your power bank to your devices while they're in the bag. The zippered front compartment has a padded tablet pocket and pockets for your mobile phone and accessories. An earbud port on the front panel allows your headphone cable to connect to your mobile devices. .

44 x 23 x 33 cm

Compliance: Cadmium tested
Recommended decoration: Screenprint



12013900

Avenue

STARK TECH 15,6" LAPTOP BRIEFCASE

600D Polyester.

This exclusively designed, security-friendly briefcase includes integrated features to keep you powered up while traveling. The TSA-Friendly laptop compartment zips down to lay flat on the X-ray belt getting you through TSA checkpoints faster and more securely. The zippered center compartment includes dedicated power bank pocket, mesh storage pockets for cables and accessories and extra room for folders and files. The smart pass-through port in the front wall allows your cables to connect from the center compartment, where your power source is located, to the front organizer pocket to charge your tablet or phone while on the go.

41 x 11 x 32 cm

Compliance: Cadmium tested
Recommended decoration: Screenprint

11994700



Avenue

ECHO 14" LAPTOP SHOULDER BAG

300D Polyester.

Exclusive design shoulder bag with imitation suede details. Zippered pocket on the flap and organisation panel under flap. Zippered main compartment is suitable for most 14" laptops. Removable and adjustable shoulder strap with padded shoulder pad.

35,5 x 8,5 x 28 cm

*Compliance: Cadmium tested
Recommended decoration: Screenprint*

11994500



Avenue

ECHO 15,6" LAPTOP BACKPACK

300D Polyester.

Exclusive design laptop backpack with imitation suede details, front zippered pocket, easy access pocket on the top and adjustable padded shoulder straps.

30 x 14 x 48 cm

*Compliance: Cadmium tested
Recommended decoration: Screenprint*

*Avenue's
Favourites*

11994600



Avenue

ECHO 15,6" LAPTOP CONFERENCE BAG

300D Polyester.

Exclusive design laptop conference bag with imitation suede details. Zippered main compartment contains a padded laptop compartment which fits most 15,6" laptops. Removable and adjustable shoulder strap with padded shoulder pad.

40 x 10,5 x 30 cm

*Compliance: Cadmium tested
Recommended decoration: Screenprint*

11994800



Avenue

ECHO TRAVEL BAG

300D Polyester.

Exclusive design travel bag with imitation suede details. Zipper front pocket, small zipper pocket inside zippered main compartment, adjustable and removable shoulder strap with padded pad.

50 x 27 x 30 cm

*Compliance: Cadmium tested
Recommended decoration: Screenprint*



ECHO



NORTH SEA

Avenue

11996500

NORTH SEA CONFERENCE BAG

Tarpaulin.

Exclusive design conference bag with zippered main pocket and zippered front pocket. Adjustable and removable shoulder strap with padded pad. reinforced double carryhandles.
40 x 5,5 x 29 cm

*Compliance: Cadmium tested
Recommended decoration: Screenprint*





11980100

Avenue

NORTH SEA SHOULDER BAG

Tarpaulin.

Exclusive design waterresistant messenger with main compartment closed by velcro closure front flap. Slash pocket inside. Zippered front pocket. Zippered pocket under flap. Adjustable shoulder strap.
37,5 x 13,5 x 32 cm

Compliance: Cadmium tested
Recommended decoration: Screenprint



11980200

Avenue

NORTH SEA BACKPACK

Tarpaulin.

Exclusive design waterresistant backpack with zippered main compartment with laptop compartment will fit most 15,4" laptops. Zippered middle compartment with slash pocket for small accessoires like phone. Vertical zippered front pocket. Adjustable padded shoulder straps and reinforced top carry handle.
33 x 14 x 46 cm

Compliance: Cadmium tested
Recommended decoration: Screenprint



11980000

Avenue

NORTH SEA TRAVEL BAG

Tarpaulin.

Exclusive design waterresistant travel bag with zippered main compartment. Zippered front pocket. Removable and adjustable shoulder strap. Carry handles on top and on both sides.
52 x 32 x 32 cm

Compliance: Cadmium tested
Recommended decoration: Screenprint



11980300

Avenue

NORTH SEA LARGE TRAVEL BAG

Tarpaulin.

Exclusive design water resistant large travelbag with zippered main compartment. Zippered front pocket. Top carry handle with padded velcro closure. Carry handles on both sides. Removable and adjustable shoulder strap.
64 x 37 x 37 cm

Compliance: Cadmium tested
Recommended decoration: Screenprint



Avenue

BOSTON 15.6" LAPTOP BACKPACK

600D Polyester.

Exclusive design laptop backpack. Main compartment has a padded laptop pocket which fits most 15.6" laptops. An organisation panel, two front zippered pockets, aluminium handle and adjustable padded shoulder straps. 29 x 10 x 38 cm

*Compliance: Cadmium tested
Recommended decoration: Screenprint*



11992001

11992000



11992100

Avenue

HARLEM 14" LAPTOP BACKPACK

600D Polyester.

Dedicated laptop compartment in the back, big main compartment, quick access pocket on the top, front zipper pocket with organisation panel and adjustable padded shoulder straps. 28 x 13 x 40 cm

*Compliance: Cadmium tested
Recommended decoration: Screenprint*



11979400

Avenue

JOURNEY 15.4" LAPTOP BACKPACK

600D Polyester.

Large main double-zippered compartment contains padded laptop compartment with velcro secure-strap, hold most 15.4" laptops. Reinforced heavy-duty rubber-trimmed top carry handle. Accessories not included. 31,7 x 12,7 x 43 cm

*Compliance: Cadmium tested
Recommended decoration: Screenprint*



11976800

Avenue

DOWN BACKPACK

Nylon.

Exclusive design padded backpack with padded handle and padded shoulder straps, zippered front pocket and large zippered main compartment.
31,5 x 14,5 x 42 cm

*Compliance: Cadmium tested
Recommended decoration: Transfer*



11979500

Avenue

CONTINENTAL 15.4" LAPTOP BACKPACK

600D Polyester.

Laptop-only section unfolds laying flat on x-ray belt expediting airport security. Holds most 15.4" laptops. Zippered main compartment. Zippered front pocket with deluxe organisation panel and key ring. Zippered top pocket with organisation and ear bud port.
29,2 x 15,2 x 41,9 cm

*Compliance: Cadmium tested
Recommended decoration: Screenprint*



11950600

Avenue

CHECKMATE 15" LAPTOP BACKPACK

600D Polyester and PVC.

The laptop-only section of this exclusive design bag unfolds to lay flat on the X-ray belt to increase your speed, convenience, and security. Holds most 15" laptops. Front zippered compartment contains organisation and file divider.
33 x 15,2 x 45 cm

*Compliance: Cadmium tested
Recommended decoration: Transfer*



11988300

Avenue

DAYTRIPPER 16" LAPTOP BACKPACK

600D Polyester.

This lightweight daypack includes a dedicated computer pocket that keeps laptops up to 16" safe and secure with side entry access. Open main compartment includes a dedicated zippered nylux-lined padded iPad pocket. Zippered top pocket with organization panel and earbud port access. Zippered lower front pocket for additional secure storage. Includes top zip lined valuables pocket, perfect for sunglasses. Two side zippered pockets. Neoprene handle. Back panel designed to slip over trolley handles.
34 x 20,5 x 46,5 cm

*Compliance: Cadmium tested
Recommended decoration: Transfer*

New



12015100



Avenue

POWER STRETCH 17" LAPTOP BACKPACK

600D Polyester.

The outside of the bag features a front tablet pocket that secures with elastic and side pockets with stretch mesh for quick access to all your mobile devices. The main compartment features a dedicated neoprene pocket for mobile power that will fit all of our Zoom™ Power devices as well as most aftermarket power solutions (not included). The smart organization inside the bag allows you to power the devices while they're in the bag by providing ports inside the bag to the front organizer pocket as well as the side pocket. Also allows you to charge your power block without having to remove it from the bag. Rear adjustable straps and trolley pass-through.
29,8 x 13,3 x 45,7 cm

Compliance: Cadmium tested
Recommended decoration: Screenprint





11979600

Avenue

NEOTEC 15.4" LAPTOP BACKPACK

840D Nylon.
Exclusive design laptop backpack with heavy padded laptop compartment, fits laptops of 15.4" and has several pockets for documents and accessories.
32 x 25 x 44 cm

Compliance: Cadmium tested
Recommended decoration: Transfer

Avenue

HARLEM 14" LAPTOP CONFERENCE BAG

600D Polyester.
With padded laptop compartment, front zipper pocket with organisation panel and adjustable shoulder strap.
36,7 x 4,8 x 26,7 cm

Compliance: Cadmium tested
Recommended decoration: Screenprint

Avenue

CHECKPOINT-FRIENDLY 15.4"
COMPUTER-BACKPACK

600D Polyester.
Exclusive design laptop bag Includes designated laptop-only section that unfolds to lay flat on an x-ray belt to increase speed through security. Side entry laptop compartment holds up to 15.4" laptops. Open main compartment includes a dedicated zippered nylux-lined padded tablet pocket. Zippered top pocket with organisation panel and ear bud port access. Unique hidden grab handle and neoprene carry handle. Back panel designed to slip over trolley handles. .
34,2 x 17,7 x 45,7 cm

Compliance: Cadmium tested
Recommended decoration: Screenprint

11907600



11991300



11991400

11991401

11991402

Avenue

SALEM 15.6" LAPTOP CONFERENCE BAG

600D Polyester.

Velcro closure flap with zipper pocket, spacious main compartment with laptop compartment, 4 inside zipper pockets, 3 pen loops, adjustable padded shoulder strap and trolley strap on the back.
41,5 x 15,5 x 31 cm

Compliance: Cadmium tested

Recommended decoration: Screenprint



11991500

Avenue

NEW JERSEY 15.6" LAPTOP CONFERENCE BAG

1680D Polyester.

Double handled laptop bag with laptop compartment inside main compartment and 10" tablet sleeve. Fully featured organiser in front zipper pocket. With trolley strap on the back and adjustable removable padded shoulder strap.
40 x 7 x 30 cm

Compliance: Cadmium tested

Recommended decoration: Transfer



Avenue's Favourites



11936702

11936701

Avenue

NEBRASKA 16" LAPTOP BAG

600D Polyester.

Exclusive and stylish exhibition bag with metal handle, adjustable shoulder strap, zipper closure main compartment with several pockets and padded laptop compartment which fits most 15.6" laptops, zipper closure front pocket and zippered back pocket.
40 x 7 x 31 cm

Compliance: Cadmium tested

Recommended decoration: Screenprint



11943100

Avenue

**SECURITY FRIENDLY BUSINESS
15.4" LAPTOP BAG**

600D Polyester and pvc.

Exclusive design laptop bag that is packed in a non woven pouch. Main compartment and zipper front pocket with several functional pockets. TSA compliant.

42 x 9 x 33 cm

*Compliance: Cadmium tested
Recommended decoration: Screenprint*



11979300

Avenue

LUX 15.4" LAPTOP BAG

Ripstop 300D polyester and 600D polyester.

Exclusive design laptop bag. Main zippered compartment holds most 15.4" laptops. Front zippered pocket with additional organisation features. Quick-access corner pocket. Zippered accessory and USB pockets. Hidden front mesh pocket. 2 carry handles and adjustable, removable comfort shoulder strap. Rear zippered pocket and trolley handle.

40,6 x 10 x 30,4 cm

*Compliance: Cadmium tested
Recommended decoration: Transfer*



Avenue

POWER STRETCH TABLET BAG

600D Polyester.

Zippered main compartment is padded for your tablet and also had dedicated neoprene pockets for your mobile power solution. The outside of the bag features a front accessory pocket that secures with elastic for quick access to all your mobile devices such as your iPhone or other smartphone. It also has a port so you can run a cable from the main compartment where your power is located to either the front accessory pocket or into a wall without having to remove your charger from the bag. This smart organization allows you to charge while on the go. Adjustable shoulder strap.

22,8 x 4,4 x 30,4 cm

*Compliance: Cadmium tested
Recommended decoration: Screenprint*



12015200

Avenue

POWER STRETCH 17" LAPTOP MESSENGER BAG

600D Polyester.

Zippered main compartment has a padded sleeve for your laptop up to 17" and a dedicated neoprene pocket for your tablet. The dedicated neoprene pocket for your mobile charging solution also had a port that runs to the outside of the bag and into the front tablet pocket so you can charge all your mobile devices without having to remove them from the bag. The outside of the bag features a front accessory pocket that secures with elastic for quick access to all your mobile devices. Side mesh pockets for your phone or cables. Adjustable shoulder strap. Trolley sleeve on back.
40,6 x 10,1 x 30,4 cm

Compliance: Cadmium tested
Recommended decoration: Screenprint



12015300



12004500



12004600

Avenue

DAYTRIPPER SLING 15.4" LAPTOP MESSENGER

600D Polyester.

This lightweight messenger is great for a daily commute or trip. The large main compartment holds your laptop. Dedicated iPad pocket will securely hold your iPad or tablet with most cases. Organization panel and additional accessory pockets under the flap. Molded EVA back keeps the bag lightweight and allows ventilation down your back when you have it securely against your back. Back panel designed to slip over trolley handles.
44,4 x 15,2 x 31,7 cm

Compliance: Cadmium tested
Recommended decoration: Embroidery

Avenue

CHECKPOINT FRIENDLY 17" LAPTOP MESSENGER BAG

600D Polyester.

Back zippered compartment holds up to 17" laptops and also has a separate Velcro pocket. Open main compartment includes a dedicated zippered nylux-lined padded iPad pocket. Protective flap with zippered front pocket that includes an organization panel and earbud port access. Deluxe organization and additional zippered pocket under flap. Two side mesh pockets. Unique hidden grab handle and adjustable padded shoulder strap with non-slip pad. Back panel designed to slip over trolley handles.
43 x 12,7 x 31,7 cm

Compliance: Cadmium tested
Recommended decoration: Embroidery



11977000

Avenue

DOWN TRAVEL BAG

Nylon.

Padded double handled exclusive design travel bag with adjustable shoulder strap, front zipper pocket, side handle and small zippered pocket inside main compartment.

51 x 26 x 26 cm

Compliance: Cadmium tested

Recommended decoration: Transfer



12003300

Avenue

NEOTEC DUFFEL BAG

600D Polyester.

Large zippered main compartment. One vented side pocket with separate zippered shoe compartment. One vented side wet pocket. Zippered hard EVA shell pocket to protect small electronics. Adjustable and padded shoulder strap and handles.

50,8 x 33 x 27,9 cm

Compliance: Cadmium tested

Recommended decoration: Transfer



12003400

Avenue

17" LAPTOP ROLLING BACKPACK

840D Nylon.

Main compartment with file dividers and computer pouch which fits most 17" laptops. Front pocket with organizer and media pocket with headphone port. Telescoping handle and inline wheels with removable covers for smooth rolling. Hideaway backpack straps and ultra comfort carry handle.
17,7 x 36 x 48,2 cm

*Compliance: Cadmium tested
Recommended decoration: Screenprint*



11951100

Avenue

15.4" LAPTOP RUCKSACK

600D Polyester and PVC.

Cabin approved, four spacious zippered compartments. Laptop compartment holds up to a 15.4" laptop. Front zippered organizational pocket. Hard EVA shell on front pocket protects small electronics.
39 x 25 x 53 cm

*Compliance: Cadmium tested
Recommended decoration: Transfer*

*Avenue's
Favourites*



11936400

Avenue

BUSINESS 15.4" LAPTOP TROLLEY

600D Polyester.

Simple yet functional exclusive design cabin approved business trolley, also ideal for small trips. Has a 15.4" laptop compartment and several other functional compartments to store your documents and accessories.
36 x 19 x 43 cm

*Compliance: Cadmium tested
Recommended decoration: Screenprint*



12003200

12003201

Avenue

EXPANDABLE CARRY-ON LUGGAGE

600D Polyester.

This carry-on luggage has an expandable main compartment and a push-button retractable handle that locks in two different heights. Two exterior zippered pockets for additional storage. Interior straps and zippered compartment hold everything in place and the lightweight design make it easy to get around. Interior mesh divider allows you to keep your clothes separate. Top and side grab handles make it easier to carry. Includes luggage ID on back panel as well as a zippered pocket for easy stashing of your tickets or other travel documents.
33 x 17,7 x 53,3 cm

*Compliance: Cadmium tested
Recommended decoration: Screenprint*



11922900



11922800

Avenue

ORANGE LINE BUSINESS BAG ON WHEELS

1680D Polyester.

Exclusive design cabin approved business bag trolley with padded laptop compartment for 17" laptops. Separate compartment for documents and front compartment for small accessories and small detachable pouch for memory sticks.
42 x 22 x 44 cm

*Compliance: Cadmium tested
Recommended decoration: Transfer*

Avenue

ORANGE LINE AIRPORTER

1680D Polyester.

Exclusive design cabin approved trolley with extendable front compartment and main zippered compartment with clothes straps.
37,5 x 26 x 52,5 cm

*Compliance: Cadmium tested
Recommended decoration: Transfer*



Avenue

17" MOBILE OFFICE HORIZONTAL SPINNER

Polycarbonate and ABS.

Trendy lightweight exclusive design hard case mobile office. Cabin approved easy control with the 4 spinner wheels. Luxury interior with divider for organised documents and stationery. Zipper with combination TSA lock for extra security.

44 x 21 x 41,5 cm

Compliance: Cadmium tested

Recommended decoration: Padprint



11957400

11957401

Avenue's
Favourites

Avenue

20" CARRY-ON SPINNER

Polycarbonate and ABS.

Cabin approved 4 wheel exclusive design spinner for manoeuvring through crowds and aisles. Interior divider organiser and zipper with TSA combination lock for extra security.

38 x 23 x 57 cm

Compliance: Cadmium tested

Recommended decoration: Padprint



11957601

11957600



11957700

11957701

Avenue

24" SPINNER

Polycarbonate and ABS.

Convenient 4 wheel exclusive design spinner for manoeuvring through crowds and aisles. Interior divider organiser and zipper with TSA combination lock for extra security.

44 x 28 x 67 cm

Compliance: Cadmium tested

Recommended decoration: Padprint



New

12016700



12-CAN COOLER SLING

600D Polyester.

Sporty backpack sling shape with zippered main compartment holds up to 12 cans. Open front pocket. Side mesh pocket. Single adjustable sling shoulder strap. Ultra Safe™ leak-proof PEVA lining. 29,2 x 15,2 x 38,1 cm

Compliance: Cadmium tested
Recommended decoration: Screenprint



12016701

New

12016301



12016300



12-CAN DRINK POCKET COOLE

600D Polyester.

Zippered main compartment holds up to 12 cans plus ice packs. Patented Thermal Drink pockets™ on top of cooler for open beverage storage. Front pocket. Adjustable padded shoulder strap. Ultra Safe™ leak-proof PEVA lining. Collapses for easy storage. 25,4 x 19 x 21,6 cm

Compliance: Cadmium tested
Recommended decoration: Screenprint

New



12016400

12016401



24-CAN EASY-ACCESS COOLER

600D Polyester.

Zippered main compartment holds up to 24 cans. Zippered front compartment. Easy-access pocket allow for quick retrieval of chilled items. Backsaver™ technology combats the strain of carrying a loaded cooler. Ultra Safe™ leak-proof PEVA lining. Collapses for easy storage. 29,2 x 22,8 x 27,9 cm

Compliance: Cadmium tested
Recommended decoration: Screenprint



New



12016600

50-CAN TABLE TOP COOLER

600D Polyester.

Unique design of this large cooler with easy-access lid and table top function makes it perfect for outdoor events and road trips. Zippered main compartment holds up to 50 cans. Open front pocket. Side mesh pocket. Top easy-access pocket with Velcro closure. Hard top lid. Dual exterior side carry handles. Backsaver® technology combats the strain of carrying a loaded cooler. Ultra Safe™ leak-proof PEVA lining. Collapses for easy storage. 41,9 x 29,2 x 27,9 cm

*Compliance: Cadmium tested
Recommended decoration: Transfer*

New



12016500



32-CAN ROLLING COOLER

600D Polyester.

Great for outdoor events. Zippered main compartment holds up to 32 cans. Open front pocket. Retractable telescoping handle extends to 38cm. Dual exterior carry handles. Ultra Safe™ leak-proof PEVA lining. Collapses for easy storage. 30,4 x 21,6 x 36,8 cm

*Compliance: Cadmium tested
Recommended decoration: Transfer*



12016501

OAKLAND



OAKLAND 14" LAPTOP BRIEF BAG

600D Polyester.

Exclusive design brief bag with water-repellent zipper on front pocket. Zippered main compartment contains a padded pocket suitable for most 14" laptops, a sleeve for a 10" tablet (iPad) and a zippered pocket. Other features include double carry handles, padded back panel, trolley tunnel on back and removable adjustable strap with padded shoulder pad.
37 x 8 x 29 cm

Compliance: Cadmium tested
Recommended decoration: Screenprint

*Avenue's
Favourites*



12007200

12007202



12007100

12007102



12006700

12006702



OAKLAND 15.6" LAPTOP MESSENGER

600D Polyester.

Exclusive design messenger with water-repellent zipper on flap. Drawstring main compartment is also covered with a flap and secured with 2 buckles and contains a padded pocket suitable for most 15.6" laptops and a sleeve for a 10" tablet (iPad). Other features include a zippered pocket under the flap, side water bottle pocket, reinforced top carry handle that is also a trolley tunnel, padded back panel and bottom and removable adjustable strap with padded shoulder pad.

37.5 x 14 x 24,5 cm

*Compliance: Cadmium tested
Recommended decoration: Screenprint*

OAKLAND 15.6" LAPTOP BACKPACK

600D Polyester.

Exclusive design backpack with water-repellent zipper on front pocket. Zippered main compartment contains a padded pocket suitable for most 15.6" laptops and a zippered pocket. Other features include reinforced top carry handle, adjustable padded shoulder straps, padded back panel with center ventilation channel and 2 side water bottle pockets.

30 x 13 x 44 cm

*Compliance: Cadmium tested
Recommended decoration: Screenprint*



12006800

12006802



12006902

12006900



OAKLAND 15.6" LAPTOP FLAP BACKPACK

600D Polyester.

Exclusive design backpack with water-repellent zipper on front pocket. Drawstring main compartment is also covered with a flap and secured with 2 buckles and contains a padded pocket suitable for most 15.6" laptops, a zippered pocket and a water bottle side pocket. Other features include reinforced top carry handle, adjustable padded shoulder straps and padded back panel with center ventilation channel.

30 x 18 x 44 cm

*Compliance: Cadmium tested
Recommended decoration: Screenprint*

OAKLAND SPORTS BAG

600D Polyester.

Exclusive design sports bag with water-repellent zipper on front pocket. Zippered main compartment contains zippered pocket for small accessories. Other features include zippered hidden side compartment to store your shoes separately, double carry handles and adjustable strap with padded shoulder pad.

48 x 27 x 27 cm

*Compliance: Cadmium tested
Recommended decoration: Screenprint*

New



12013000

FIELD & CO.

TABLET MESSENGER BAG

Canvas 18 oz. Cotton and imitation leather.

Exclusive design tablet messenger with vintage good looks and intelligent design for your modern devices. Main compartment is padded and designed specifically to hold your iPad or other tablet device. Unique Cambridge Collection plaid lining is visible when the flap is open. Unique Field & Co.™ vintage branding elements and hardware.

24,7 x 5,7 x 26,1 cm

Compliance: AZO • Non-allergenic dyestuff • Cadmium tested
Recommended decoration: Screenprint

New



12012900

FIELD & CO.

17" LAPTOP MESSENGER BAG

Canvas 18 oz. Cotton and imitation leather.

Exclusive and intelligent design laptop messenger for your modern devices. Large main compartment includes padded laptop sleeve and padded iPad or tablet pocket. Two large front pockets with flaps protect your additional accessories and the side pocket will hold your water bottle. Unique Field & Co.™ vintage branding elements and hardware including a unique Cambridge Collection plaid lining the inside.

43 x 12,7 x 31,7 cm

Compliance: AZO • Non-allergenic dyestuff • Cadmium tested
Recommended decoration: Screenprint

New

FIELD & CO.

DUFFEL

Canvas 18 oz. Cotton and imitation leather.

Exclusive design duffel, made of cotton canvas, features a large main compartment and unique Field & Co.™ details. Vinyl accents, front zippered pocket and durable handles. Sides can clip down when you are carrying less, or you can unclip the sides when the bag is fully stuffed. Also features trolley pass-through.

50,8 x 24,1 x 27,9 cm

Compliance: AZO • Non-allergenic dyestuff • Cadmium tested
Recommended decoration: Screenprint



12012800



FIELD & CO.

BACKPACK

Canvas 18 oz. Cotton and imitation leather.

Exclusive design backpack with open main compartment with pull-cord closure. Protective flap closes with distressed silver clasped hardware. Open front pocket with pen loop. Fold over side pockets with Velcro closures. Adjustable backpack straps and carry handle. Unique Field & Co.™ vintage branding elements and hardware.

30,4 x 15,5 x 43,8 cm

*Compliance: AZO • Non-allergenic dyestuff • Cadmium tested
Recommended decoration: Screenprint*



12012700



12000101

12000100

MARKS (M) AN

NAVIGATOR 15,6" LAPTOP BACKPACK

High density 600D polyester.

Exclusive design laptop backpack with zippered front pocket with organizer. Zippered main compartment with 15,6" laptop compartment and tablet compartment. Adjustable padded shoulder straps. Top carry handles. Trolley tunnel on backside. Elastic tunnel and loop on the side at the bottom to secure your umbrella or water bottle.
30 x 10 x 44 cm

Compliance: Cadmium tested

Recommended decoration: Screenprint



12000001

12000000

MARKS (M) AN

NAVIGATOR 15,4" LAPTOP BACKPACK DELUXE

High density 600D polyester.

Exclusive design laptop backpack with zippered front pocket, front compartment with organizer inside. Zippered mid compartment with organizer, easy access top pocket, main compartment suitable for laptops up to 17" and tablet compartment. Adjustable padded shoulder straps. Top carry handles. Trolley tunnel on backside. Elastic tunnel and loop on the side at the bottom to secure your umbrella or water bottle.
33 x 20 x 47 cm

Compliance: Cadmium tested

Recommended decoration: Screenprint

NAVIGATOR





11998901

11998900

MARKS (M) AN

NAVIGATOR TABLET CONFERENCE BAG

High density 600D polyester.

Exclusive design bag with zippered front pocket with organizer. Zippered main compartment suitable for up to 13" laptop and tablet. Carry handles. Elastic tunnel and loops on the side to secure a paper or magazine. 32 x 4 x 25 cm

*Compliance: Cadmium tested
Recommended decoration: Screenprint*



11998801

11998800

MARKS (M) AN

NAVIGATOR 14" LAPTOP CONFERENCE BAG

High density 600D polyester.

Exclusive design laptop bag with zippered front pocket including organizer, zippered main compartment with 14" laptop compartment and tablet compartment. Removable and adjustable shoulder strap. Carry handles. Trolley tunnel on backside. Elastic tunnel and loop on the side at the bottom can be used to secure your section umbrella or water bottle. 37 x 8 x 29 cm

*Compliance: Cadmium tested
Recommended decoration: Screenprint*

*Avenue's
Favourites*



11997801

11997800

MARKS (M) AN

NAVIGATOR 15,6" LAPTOP BRIEFCASE

High density 600D polyester.

Exclusive design laptop bag with zippered front pocket, zippered front compartment with organizer inside, zippered mid compartment with organizer inside. Main 15,6" laptop compartment inclusive tablet compartment. Removable and adjustable shoulder strap. Carry handles. Trolley tunnel on backside. Elastic tunnel and loop on the side at the bottom to store your umbrella or water bottle. 41 x 16,5 x 32 cm

*Compliance: Cadmium tested
Recommended decoration: Screenprint*



11999901

11999900

MARKS (M) AN

NAVIGATOR 14" LAPTOP MESSENGER

High density 600D polyester.

Exclusive design Messenger with zippered front pocket on flap. Two zippered front pockets and zippered mid compartment under the flap with organizer inside. Zippered main compartment for 14" laptop and Tablet compartment. Removable and adjustable shoulder strap. Carry handles. Trolley tunnel on backside. Elastic tunnel and loop on the side at the bottom to secure your umbrella or water bottle. 36 x 15 x 27 cm

*Compliance: Cadmium tested
Recommended decoration: Screenprint*



11981700

MARKS MAN

HORIZON iPad SHOULDER BAG

High density 300D polyester.

Horizon exclusive design iPad bag with inside zipper pocket and adjustable shoulder strap.
20,5 x 4 x 26,5 cm

*Compliance: Cadmium tested
Recommended decoration: Transfer*



11981200

MARKS MAN

HORIZON MESSENGER

High density 300D polyester.

Exclusive design messenger bag with adjustable shoulder strap and back zipper pocket.
37 x 7,5 x 29 cm

*Compliance: Cadmium tested
Recommended decoration: Transfer*



11981400

MARKS  AN

HORIZON 15.6" SLIM LAPTOP BRIEFCASE

High density 300D polyester.

Exclusive design slim brief features a front pocket, adjustable shoulder strap and padded compartment for 15.6" laptop.
37 x 4 x 28,5 cm

Compliance: Cadmium tested
Recommended decoration: Transfer



12000300

MARKS  AN

HORIZON 14" LAPTOP CONFERENCE BAG

High density 300D polyester.

Exclusive design bag with zippered pocket on flap with a unique buckle closure. Organizer under flap. Zippered main compartment for 14" laptop. Adjustable padded shoulder strap. Carry handle. Trolley tunnel on backside.
35,5 x 7,5 x 26 cm

Compliance: Cadmium tested
Recommended decoration: Screenprint



11981300

MARKS  AN

HORIZON HYBRID BAG

High density 300D polyester.

Revolutionary exclusive design 4 in 1 bag, a simple twist of the strap turns this bag from a shopper into a messenger, vertical shoulder bag or backpack.
30,5 x 8,5 x 40 cm

Compliance: Cadmium tested
Recommended decoration: Screenprint



12007400

MARKS  AN

HORIZON 14" LAPTOP BACKPACK

High density 300D polyester.

Exclusive design backpack suitable for most 14" laptops also includes inside the zippered main compartment a sleeve for a 10" tablet (iPad). Other features include a front pocket with a snap-closure flap, side water bottle pocket with special closure that can be secured in the top loop when a bottle is inside, reinforced top and side carry handles, padded back panel and reinforced adjustable padded shoulder straps.
28 x 11 x 39 cm

Compliance: Cadmium tested
Recommended decoration: Transfer

HORIZON



11981100

MARKS  AN

HORIZON LAPTOP BACKPACK ROLLTOP

High density 300D polyester.

Exclusive design backpack features a padded 15,4" laptop compartment and tablet sleeve, zipper side pocket and unique buckle closure.
30 x 13,5 x 41,5 cm

Compliance: Cadmium tested
Recommended decoration: Transfer

11981500



MARKS  AN

HORIZON TRAVEL BAG

High density 300D polyester.

Exclusive design travel bag features an adjustable shoulder strap, front compartment and bag zipper pocket. Extended size is 77 x 24 x 49.
52 x 24 x 32 cm

Compliance: Cadmium tested
Recommended decoration: Transfer



11981600

MARKS  AN

HORIZON BACKPACK TRAVEL BAG

High density 300D polyester.

Double feature exclusive design bag, backpacks turns into a travel bag when the straps are stored in the bottom compartment, bag has a side zipper pocket and side small compartment.

29,5 x 23,5 x 44,5 cm

*Compliance: Cadmium tested
Recommended decoration: Screenprint*



11971600

MARKS  AN

ODYSSEY 15.4" LAPTOP SLIM BRIEFCASE

Tarpaulin and 420D nylon.

Exclusive design slim laptop case with adjustable shoulder strap, padded handle, side opening for main compartment that fit's most 15,4" laptops, front zipper pocket and back strap to put over trolley handle.

39,5 x 4,3 x 29,5 cm

*Compliance: Cadmium tested
Recommended decoration: Screenprint*



11972300

MARKS  AN

ODYSSEY 15.4" LAPTOP MESSENGER

Tarpaulin and 420D nylon.

Exclusive design messenger bag with padded laptop compartment fits most 15,4" laptops and has a separate tablet sleeve and a full organisation panel under the front flap.

40,5 x 10 x 28 cm

*Compliance: Cadmium tested
Recommended decoration: Screenprint*



12000200

MARKS  AN

ODYSSEY 14" LAPTOP CONFERENCE BAG

Tarpaulin and 420D nylon.

Exclusive design bag with zippered front pocket with organizer, zippered main compartment for 14" laptop and Tablet. Removable and adjustable padded shoulder strap. Carry handles. Trolley tunnel on backside.

36 x 7 x 27,5 cm

*Compliance: Cadmium tested
Recommended decoration: Screenprint*

ODYSSEY 15.4" LAPTOP BRIEFCASE

Tarpaulin and 420D nylon.

Exclusive design briefcase suitable for 15.4" laptops with tablet sleeve, several compartments to store documents and accessories and a back strap to carry on a trolley.
39 x 11 x 30 cm

Compliance: Cadmium tested
Recommended decoration: Screenprint



11972600

Avenue's
Favourites

12007500



11972700



ODYSSEY 14" LAPTOP BACKPACK

Tarpaulin and 420D nylon.

Exclusive design backpack suitable for most 14" laptops also includes inside the zippered main compartment a sleeve for a 10" tablet (iPad) with nylex lining and a document pocket. Other features include zippered front pocket, reinforced top carry handle, padded back panel and reinforced adjustable padded shoulder straps.
31 x 9 x 42 cm

Compliance: Cadmium tested
Recommended decoration: Screenprint

ODYSSEY 15.4" LAPTOP BACKPACK

Tarpaulin and 420D nylon.

Exclusive design bag features a small front zipper pocket, main compartment with organisation panel and several pockets, padded laptop compartment with nylex lining, side zipper pocket, padded handle and shoulder straps.
30 x 18,5 x 45 cm

Compliance: Cadmium tested
Recommended decoration: Transfer



11972500

MARKS  AN

ODYSSEY TRAVEL BAG

Tarpaulin and 420D nylon.

Exclusive design large travel bag features a adjustable padded shoulder strap, 2 padded handles, large front zipper pocket, side zippered shoe compartment and a small zipper pocket inside the main compartment.
58 x 29 x 29 cm

Compliance: Cadmium tested
Recommended decoration: Screenprint



11972800

MARKS  AN

ODYSSEY MOBILE OFFICE VERTICAL

Tarpaulin and 420D nylon.

Exclusive design cabin approved trolley bag with spacious main compartment, laptop compartment suitable up to 17", separate tablet compartment and several zipped organiser pockets.
35 x 24 x 46,5 cm

Compliance: Cadmium tested
Recommended decoration: Screenprint



LUNAR LIGHTWEIGHT 15.6" LAPTOP BACKPACK

420D Ripstop Polyester.

The bag is constructed from a nylon box dobby with a water resistant coating including subtle reflective accent materials and reflective Elleven logo print for increased visibility at night. The design efficiently features a front vertical zip pocket with a waterproof zipper. The large main compartment has a multi-layered storage panel on the front wall and the back wall has a padded tablet pocket. The zippered, fully padded laptop compartment in the back will hold up to a 15.6" laptop. A combination of lightweight mesh and fabric straps paired with a soft mesh padded back panel keep the bag comfortable, while keeping the bag light as a feather. The back includes the trolley band. Two exterior mesh pockets easily fit larger water bottles or extra gear. 26,6 x 11,4 x 43,2 cm

*Compliance: Cadmium tested
Recommended decoration: Screenprint*



12015400

FLARE 15.6" LAPTOP LIGHTWEIGHT BACKPACK

420D Ripstop Polyester.

The Flare is both functional and comfortable. The bag is constructed from a nylon box dobby with a water resistant coating and reflective Elleven logo print for high visibility at night. The bottom of the bag is lightweight tarpaulin making it water resistant and easy to clean. Features a bottom pocket, roomy enough to fit power cords, headphones or even a light coat. The large front pocket has a waterproof zipper. The large main compartment with extra deep zipper opening includes an organizer panel on the front wall and a tablet pocket on the back wall. The zippered, fully padded laptop compartment in the back will fit up to a 15.6" laptop. Soft mesh padded back panel and cushy straps are both comfortable and ergonomic while keeping the bag light as a feather. The back includes the trolley band. 30,4 x 15,2 x 50,1 cm

*Compliance: Cadmium tested
Recommended decoration: Screenprint*



12015500

MOTION 15" LAPTOP DAYPACK

600D Polyester and 420D nylon.

This exclusive design packs all the organization you could ever need in a compact design without sacrificing functionality and comfort. Features a padded laptop compartment which fits most 15" laptops, lined pocket for your iPad/tablet or eReader, dedicated pockets for things such as cords in addition to the large main compartment. Side grab handle makes getting in and out of a car or off a plane easier. Quick access pocket for your phone, passport or other valuables. Padded back and straps for extra comfort. Back panel designed to slip over trolley handles. 32 x 13 x 44,5 cm

*Compliance: Cadmium tested
Recommended decoration: Screenprint*



12003900



11954400

eleven

**PROTON CHECKPOINT FRIENDLY
17" COMPUTER BACKPACK**

Dobby nylon with scuba.

This exclusive design has a designated laptop-only section that unfolds to lay flat on an x-ray belt to increase speed, convenience and security. Side entry laptop compartment holds up to 17" laptops. Main zippered compartment with file divider, interior side pockets and removable TechTrap elastic organiser panel. Zippered media pocket accesses ear bud port. Front zippered pocket and key fob. Front lower & hidden pockets for valuables. 3 side roomy zippered pockets. Back panel designed to slip over trolley handles.
41,9 x 22,9 x 48,3 cm

Compliance: Cadmium tested
Recommended decoration: Transfer



11988500

eleven

**VAPOR CHECKPOINT FRIENDLY
17" COMPUTER BACKPACK**

600D Polyester.

This exclusive design has a designated TSA-friendly laptop-only section that unfolds to lay flat on the X-ray belt to increase your speed, convenience and security. Main zippered compartment includes multiple slash pockets, a dedicated padded iPad pocket and removable Large Tech Trap for all your organization needs. Front zippered pocket with deluxe organization. Hidden pockets for valuables and easy-access pocket for tickets. Padded back and compression shoulder straps for extra comfort and adjustable chest strap to help ease the burden on your back. Back panel designed to slip over trolley handles.
35,5 x 49,5 x 23,5 cm

Compliance: Cadmium tested
Recommended decoration: Transfer



12006400

eleven

**VAPOR CHECKPOINT FRIENDLY
17" LAPTOP ATTACHÉ**

600D Polyester and nylon.

This exclusive design has a designated TSA-friendly laptop-only section that unfolds to lay flat on the X-ray belt to increase your speed, convenience and security. Spacious main zippered compartment includes multiple slash pockets, a dedicated padded iPad/tablet pocket and removable large techtrap for all your organization needs. Includes a separate top lined pocket for an iPad Mini. Front zippered pocket. Side zippered pocket has a pass-through so you can store your mobile power inside and charge your phone through the side pocket. Padded removable and adjustable shoulder strap. Back panel designed to slip over trolley handles.
45 x 12 x 32 cm

Compliance: Cadmium tested
Recommended decoration: Transfer



12004100

eleven

**PROTON CHECKPOINT FRIENDLY
17" COMPUTER ATTACHÉ**

Dobby nylon and scuba.

Includes designated laptop-only section that unfolds to lay flat on the X-ray belt to increase your speed through security. Back zippered compartment holds up most 17" laptops and has separate zippered pocket. Main zippered compartment for file dividers and mesh pocket organization. Front zippered pocket holds the removable techtrap elastic organizer panel. Elastic shock cord on exterior side pocket for additional storage. Molded handle and padded, detachable, adjustable shoulder strap. Back panel designed to slip over trolley handles.
48 x 10,5 x 38,5 cm

Compliance: Cadmium tested
Recommended decoration: Transfer

**PROTON CHECKPOINT FRIENDLY
17" COMPUTER MESSENGER**

Dobby nylon with scuba.

This exclusive design has a designated laptop-only section that unfolds to lay flat on an x-ray belt to increase speed, convenience and security. Back zippered compartment holds up to 17" laptops and has separate zippered pocket for files or cords. Main zippered compartment with file dividers. Front zippered pocket holds the removable TechTrap elastic organiser panel and includes a media pocket with access to an ear bud port. Deluxe organisation file folder and zippered pocket under flap. Back panel designed to slip over trolley handles.

37,2 x 7 x 31,8 cm

*Compliance: Cadmium tested
Recommended decoration: Transfer*

11954300



PROTON TRAVEL BAG

Dobby nylon.

Zippered main compartment with U-shaped opening. Front top media pocket with earbud port. Large zippered front pocket includes removable Tech Trap organizer panel and pocket organization. Large ventilated side pocket holds shoes or damp garments. Additional side zippered accessory pocket with exterior elastic shock cord for maximum storage. Handles made of durable webbing with comfortable handle wrap. Padded, detachable, adjustable shoulder strap. Signature eleven lining and hardware.

56 x 25,5 x 30,5 cm

*Compliance: Cadmium tested
Recommended decoration: Transfer*

11988400



PROTON WHEELED DUFFEL BAG

Dobby nylon and scuba.

Zippered main compartment with U-shaped opening. Front top nylux-lined media pocket. Large zippered front pocket includes removable techtrap organizer panel and pocket organization. Two large gusseted pockets include an extended interior shoe pocket. Additional exterior side zippered pocket. Elastic shock cord on top panel for maximum storage. ID window on back. Recessed, telescoping handle and inline skate wheels with corner protectors. Molded side grab handle with neoprene padding, two top webbed grab handles, and main handles made of durable webbing with a comfortable handle wrap. Signature eleven™ lining and hardware.

68 x 31,1 x 35 cm

*Compliance: Cadmium tested
Recommended decoration: Transfer*

12005600



**PROTON CHECKPOINT FRIENDLY
17" COMP WHEELED BACKPACK**

Dot doobby nylon with scuba.

Cabin approved trolley, main zippered compartment includes TSA-friendly laptop compartment expediting airport security. Holds most 17" laptops. File dividers and ear bud port access. Zippered media pocket. Front zippered pocket. Hideaway backpack straps and comfort carry handle. Exclusive design.

30,5 x 16,5 x 45,7 cm

Compliance: Cadmium tested

Recommended decoration: Transfer



11954500

12005700



VAPOR 17" COMPUTER ROLLING UPRIGHT

210D Nylon, 600D polyester and 150D polyester.

The Vapor 17" computer rolling upright features a unique padded computer sleeve that fits most 17" laptops that can be accessed from the top front panel. Lower front pocket has lined iPad/tablet pocket. Also features everything you would expect in a piece of luggage like corner mounted inline-skate wheels, telescoping handle, main compartment with tie-down straps and mesh divider for your laundry. Top front pocket has organization for all of your accessories. Bag has side, bottom and top grab handles to make it easier to carry in tight spaces.

34,2 x 24,1 x 53,3 cm

Compliance: Cadmium tested

Recommended decoration: Transfer

11964900



**PROTON CHECKPOINT FRIENDLY
17" COMPUTER ATTACHE**

Dobby nylon and scuba.

Cabin approved large main zippered compartment includes removable padded TSA-compliant laptop sleeve expediting airport security. Holds most 17" laptops. Main zippered compartment is spacious enough for an overnight trip. Additional zippered compartment for file dividers and mesh pocket organization. Front zippered pocket includes removable Tech Trap organizer panel and deluxe organization. Exclusive design.

44,5 x 22,9 x 38 cm

Compliance: Cadmium tested

Recommended decoration: Transfer



12007800



15.6" LAPTOP CASE

600D Polyester.

This laptop case is the epitome of "just right." Tailored case compatible with most laptops with a 15.6" screen with a padded laptop compartment walls provide extra protection. Slip pocket keeps documents separated from other items in your bag. Front pocket panel provides basic organization for small daily accessories. Front pocket features a wide base for bulky items like a power brick. Carry comfortably with neoprene-lined, padded handles and a removable strap with anti-slip shoulder pad.

43,9 x 7,8 x 35 cm

Compliance: Cadmium tested
Recommended decoration: Screenprint



11985400



15.6" LAPTOP AND iPad BRIEFCASE

Polyester.

Exclusive design laptop bag with slim compact case has separate protective pockets for both a laptop up to 15.6" and an iPad/10.1" tablet. Front pocket stores bulky power cords neatly in the bottom and out of the way. Organizer panel in front pocket with dedicated storage for external hard drive, pens and other accessories. Zippered front pocket keeps your smartphone secure yet easily accessible. Comfortable, removable shoulder strap and padded handle for easy portability. Luggage strap securely attaches slim case to most rolling luggage.

42 x 7,6 x 35,3 cm

Compliance: Cadmium tested
Recommended decoration: Transfer



14.1" LAPTOP ATTACHÉ

Nylon.

Exclusive design laptop bag with protective storage for both your laptop and iPad or tablet. Thickly padded laptop compartment sized to fit laptops with up to a 14.1 inch display. Slim iPad pocket is perfectly sized and nylex-lined to ensure your iPad remains protected among the items in your bag. Files remain crisp and unbent in their designated pocket, separated from your electronics. Zippered security pocket keeps your smartphone or passport secure against your body. Slightly extended top carry handle quickly slips over your wrist if your hands are full. Removable padded shoulder strap provides a comfortable carrying option.

36,5 x 7,5 x 28 cm

Compliance: Cadmium tested
Recommended decoration: Transfer

11985600





12007900



15.6" LAPTOP AND TABLET CASE

600D Polyester.

This asymmetrically quilted case with dedicated laptop compartment sized to fit laptops with up to a 15.6" display. Nylux-lined, padded pocket protects up to a 10.1 inch tablet. Organization panel inside the front pocket stores your cell phone, iPod® and business essentials while also allowing plenty of space for power cords. Neoprene-padded carry handles and a removable no-slip shoulder strap provide comfortable carrying options. Pass through along the back panel easily slips over the handle of rolling luggage.

41 x 7,5 x 29 cm

*Compliance: Cadmium tested
Recommended decoration: Screenprint*



12005400



17" LAPTOP AND TABLET CASE

600D Polyester.

This asymmetrically quilted case with dedicated laptop compartment sized to fit laptops with up to a 17" display. Nylux-lined, padded pocket protects up to a 10.1 inch tablet. Organization panel inside the front pocket stores your cell phone, iPod® and business essentials while also allowing plenty of space for power cords. Neoprene-padded carry handles and a removable no-slip shoulder strap provide comfortable carrying options. Pass through along the back panel easily slips over the handle of rolling luggage.

45 x 7,5 x 33 cm

*Compliance: Cadmium tested
Recommended decoration: Screenprint*



14.1" LAPTOP AND iPad MESSENGER

Nylon.

Exclusive design Messenger with thickly padded laptop compartment sized to fit ultrabooks/laptops with up to a 14.1 inch display. Slim iPad/10.1" tablet pocket is perfectly sized and nylux-lined to ensure your iPad remains protected among the items in your bag. Roomy main compartment fits your daily notebook, large headphones, files or other accessories. Zippered, nylux-lined front pocket keeps your smartphone secure yet accessible. Comfortable shoulder strap with shoulder pad for easy portability.

40,4 x 10 x 30,5 cm

*Compliance: Cadmium tested
Recommended decoration: Transfer*



11985700



14" CHECKPOINT FRIENDLY LAPTOP CASE

1682D Nylon.

Dedicated compartments protect both a laptop with a 14-inch screen and an iPad or 10.1-inch tablet. Checkpoint Friendly– Designed in compliance with TSA guidelines so your laptop does not need to be removed when passing through airport security. Grab 'N' Go™ design lets you quickly exit security without having to re-zip case. Full-size document compartment. Smart Organization™ panel provides a place for all your electronics, gadgets and accessories. Luggage strap securely attaches briefcase to most rolling luggage. 38 x 11 x 31 cm

Compliance: Cadmium tested
Recommended decoration: Transfer



11985900

Avenue's Favourites



11985500



17" LAPTOP BACKPACK

600D Polyester.

Exclusive design backpack with dedicated laptop compartment holds up to 17" widescreen laptops. Expansive interior storage holds books, files and folders. Organization panel stores your portable electronics, pens and more. Speed Pocket™ - A quick access, secure place to put valuables (watch, keys, cell phone etc.) prior to passing through airport security. External mesh pocket.

30,5 x 21,6 x 45,7 cm

Compliance: Cadmium tested
Recommended decoration: Transfer



12008000



JAUNT 15.6" LAPTOP BACKPACK

400D Nylon.

An integrated compartment for your 15.6" laptop, sleeve for your tablet and interior cord storage pocket keep your electronics on hand. Quick-access front pocket stores your most-used items while organizational panel keep your accessories arranged.

30,9 x 26,9 x 44,9 cm

Compliance: Cadmium tested
Recommended decoration: Transfer



16" LAPTOP BACKPACK

600D Polyester.

Padded computer compartment holds 16" laptop. Quick access front grab handle. Front zippered organizer includes iPhone/smartphone pocket, pen loop, zippered valuables pocket, place for your power cord. Top zippered sunglasses/phone pocket lined with scratch resistant protective lining. Strap management system keeps the excess shoulder strap rolled up and out of the way. Side zippered pockets for water bottles or power cords. Padded cushioned back panel support.

35,5 x 24,1 x 45 cm

Compliance: Cadmium tested
Recommended decoration: Embroidery



12005500



11985800



12008100



15.6" LAPTOP BACKPACK

210D Nylon.

Exclusive design laptop backpack with dedicated laptop compartment disappears underneath straps to protect laptops with up to a 15,6" display. Padded, nyllex-lined iPad pocket prevents scratches to your iPad or 10" tablet screen. Front compartment features storage pockets for small electronics and a zippered pocket and additional space for a power brick. Front exterior slip pocket allows quick access to a boarding pass or other transportation ticket. Padded, mesh back panel and shoulder straps.

34 x 15 x 50 cm

Compliance: Cadmium tested
Recommended decoration: Transfer



GRIFFITH PARK 15" LAPTOP BACKPACK

450D Nylon.

Dedicated compartments for a 15" MacBook®/15" Laptop and an iPad®/10" tablet plus an easy-access, plush lined phone pocket keep your gear on hand. Griffith Park's hard-to-beat comfort lies in the generous air mesh padding and lightweight contoured foam backpack to keep you cool and make your load a breeze to carry.

34,5 x 6,6 x 48 cm

Compliance: Cadmium tested
Recommended decoration: Transfer



11920900



14" - 15.4" LAPTOP BACKPACK

840D Nylon.

Exclusive design, holds up to 15.4" laptops. Interior organiser panel provides extra storage for files and other computer accessories. Thick foam padding and durable, lightweight material provides superior protection for computer equipment.

36 x 15,2 x 47 cm

*Compliance: Cadmium tested
Recommended decoration: Transfer*



11944700



SECURITY FRIENDLY 16" LAPTOP BACKPACK

420D Nylon and leather.

Exclusive design backpack fit most laptops with a 16" screen Security Friendly– Designed in compliance with TSA so your laptop doesn't need to be removed when passing through US airport security. Separate file compartment stores papers.

34,3 x 15,2 x 45,7 cm

*Compliance: Cadmium tested
Recommended decoration: Embroidery*

11986100



11997700



ROLLING 15.6" LAPTOP CASE

900D Polyester and 600D Polyester.

Exclusive design laptop bag with thickly padded laptop compartment protects laptops with up to a 15.6 inch display. Main compartment features storage for a change of clothes. Divider secures to the side of the case to compress and cover clothes while offering additional storage with mesh pockets on the backside and expandable pockets on front. Organization panel along with zippered mesh pockets. Tilt-out file compartment keeps your files separated and presentable.

42,4 x 21,1 x 34,5 cm

*Compliance: Cadmium tested
Recommended decoration: Transfer*



15.6" LAPTOP AND TABLET ROLLER

Nylon.

Exclusive design cabin approved laptop trolley your 15.6" laptop and tablet are protected in two dedicated compartments while a change of clothes and all your other business accessories stay organized in thoughtfully designed pockets.

47 x 41 x 24 cm

*Compliance: Cadmium tested
Recommended decoration: Transfer*



BRISBANE



BRISBANE COOLER BACKPACK

300D Polyester.

Trendy exclusive design cooler rucksack with several functional pockets.
44 x 18 x 34 cm

Compliance: Cadmium tested
Recommended decoration: Transfer



11912301



11912300

11912303



11975603



11975601



11975602



11975600



BRISBANE SAILOR BAG

600D Polyester and 300D ripstop polyester.

Exclusive design duffel bag features a shoe compartment, drawstring closure main compartment, front zipper pocket and adjustable shoulder strap. 30,5 x 50,5 cm

*Compliance: Cadmium tested
Recommended decoration: Transfer*

11962402



11962401



11962400



11962403



BRISBANE 15.4" LAPTOP RUCKSACK

600D Polyester and 300D ripstop polyester.

Exclusive design sporty rucksack with padded computer compartment and various functional pockets. 31 x 19 x 46 cm

*Compliance: Cadmium tested
Recommended decoration: Screenprint*



11941701



11941702



11941703



11975501



11975502



11975500

11941700



BRISBANE SPORTS BAG

600D Polyester and 300D ripstop polyester.

Ideal sports bag for athletes that need to protect their gear from the muddy fields or wet locker room floors. Has an extra zipper pocket on the front and an adjustable shoulder strap. 50 x 29 x 29 cm

*Compliance: Cadmium tested
Recommended decoration: Transfer*



11975503



BRISBANE SPORTS BAG

600D Polyester and 300D ripstop polyester.

Exclusive design large sports bag with 2 side zipper pockets and front zipper pocket. 61,5 x 33,5 x 30 cm

*Compliance: Cadmium tested
Recommended decoration: Transfer*



YORK



11994100



11994101



11994102



11994103



11994300



11994301



11994302



11994303



YORK DUFFEL

300D Polyester.

Exclusive design sport bag with zippered front pocket, inside zippered pocket adjustable padded shoulder strap.

41 x 24 x 24 cm

*Compliance: Cadmium tested
Recommended decoration: Screenprint*

YORK BACKPACK

300D Polyester.

Exclusive design backpack with zipper front compartment, small inside zipper pocket and adjustable padded shoulder straps.

28 x 15,5 x 41,5 cm

*Compliance: Cadmium tested
Recommended decoration: Screenprint*



11994200



11994201



11994202



11994203



11994400



11994401



11994402



11994403



YORK SPORT BAG

300D Polyester.

Exclusive design sport bag with zippered front pocket, inside zippered pocket adjustable padded shoulder strap.

50 x 28,5 x 30 cm

*Compliance: Cadmium tested
Recommended decoration: Screenprint*

YORK SHOULDER BAG

300D Polyester.

Exclusive design shoulder bag with zipper on flap and organisation panel under the flap. Adjustable padded shoulder strap.

34,5 x 11,8 x 29,5 cm

*Compliance: Cadmium tested
Recommended decoration: Screenprint*

Avenue's
Favourites



11931400



WEMBLEY BACKPACK

600D Polyester.

Sporty exclusive design rucksack with zippered main compartment with media pocket and a headphone port. Front zippered pocket with an organisation panel.

47,5 x 32,5 x 15 cm

Compliance: Cadmium tested
Recommended decoration: Screenprint



11953000



WEMBLEY GYM BAG

600D Polyester.

Exclusive designed sports bag with big main compartment, front zipper pocket, mesh water bottle pocket on front and adjustable padded shoulder strap.

45 x 28 x 27 cm

Compliance: Cadmium tested
Recommended decoration: Screenprint



12014800



WEMBLEY 17" LAPTOP SHOULDER BAG

600D Polyester.

This soulder bag holds most 17" laptop. It has a large zippered main compartment with built-in laptop sleeve. Zippered pocket with organization panel under flap. Two zippered pockets under flap. Flap can be closed by velcro closure. Side water bottle pocket. Adjustable shoulder strap. Signature Slazenger™ hardware and logo.

40,6 x 10,1 x 38,1 cm

Compliance: Cadmium tested
Recommended decoration: Screenprint



11931500



WEMBLEY SPORTS BAG

600D Polyester.

Exclusive design bag features a zippered main compartment, front zippered pocket with organisation panel, ID window and a headphone port. Also includes 2 side velcro accessory pockets and adjustable shoulder strap.
27,5 x 55 x 27,5 cm

Compliance: Cadmium tested
Recommended decoration: Screenprint



11970000



WEMBLEY LARGE TRAVEL BAG

600D Polyester.

Large travel bag exclusive design with trolley system and 2 large separate compartments and 2 zippered pockets for easy access to documents and accessories.
32 x 42 x 67 cm

Compliance: Cadmium tested
Recommended decoration: Screenprint



11970100



WEMBLEY TROLLEY BACKPACK

600D Polyester.

Wheeled cabin approved 15,5" exclusive design laptop backpack makes travelling easy with its comfortable telescopic handle, heavy-duty wheels and easy conversion to a backpack for hands-free transport.
33 x 26 x 48 cm

Compliance: Cadmium tested
Recommended decoration: Screenprint



11970200



WEMBLEY TROLLEY

600D Polyester.

Exclusive design cabin approved trolley with zippered main compartment, 2 buckle closures and a zipper front pocket.
35 x 20 x 52 cm

Compliance: Cadmium tested
Recommended decoration: Screenprint



CHESTER



CHESTER SMALL MESSENGER BAG

600D Polyester.

Exclusive design small messenger bag with an open main compartment under the flap. The main compartment includes a secure zippered pocket with a dog-ring for your keyring. The messenger flap features a vertical zippered pocket and a pig-snout to store small accessories like keyrings or a carabiner. An open pocket underneath the flap offers room to store some accessories like your mobile phone. The flap can be closed by velcro. Adjustable shoulder strap.
20 x 8,5 x 25,5 cm

Compliance: Cadmium tested
Recommended decoration: Screenprint



12014600

New



12014400



CHESTER SAILOR BAG BACKPACK

600D Polyester.

Exclusive design sailor bag backpack with a cotton drawstring closure and a vertical zipper closure on the back panel for easy access. An extra flap is included below the drawstring closure for extra protection of your belongings. The front panel features a pig-snout to store small accessories like keyrings or a carabiner. Two adjustable padded shoulder straps.

ø 23,5 x 50 cm

Compliance: Cadmium tested
Recommended decoration: Screenprint

Avenue's
Favourites

New



12014200



CHESTER 15,6 " LAPTOP BACKPACK

600D Polyester.

Exclusive design backpack. Zippered main compartment with a padded laptop sleeve suitable for most 15.6" laptops, a padded tablet sleeve which fits up to 10" tablets and room for books and folders. The front panel features a vertical zippered front pocket and a pig-snout to store small accessories like keyrings or a carabiner. Large side pocket with a cotton drawstring and buckle closure. Shoulder straps with a comfortable shape are padded and adjustable. Reinforced top carry handle.

30 x 12,5 x 47 cm

Compliance: Cadmium tested
Recommended decoration: Screenprint

New



12014500



CHESTER 17" LAPTOP SHOULDER BAG

600D Polyester.

Exclusive design shoulder bag. The zippered main compartment features a padded laptop sleeve to hold most 17" laptops and a padded tablet sleeve to hold 10" tablets. Besides these sleeves there is enough room in the main compartment to carry books, files and folders. The messenger flap features a vertical zippered pocket and a pig-snout to store small accessories like keyrings or a carabiner. The flap can be secured by adjustable buckles. Adjustable shoulder strap with padded shoulder pad for extra comfort.

41 x 12 x 33 cm

Compliance: Cadmium tested

New



12014300



CHESTER DUFFEL

600D Polyester.

Exclusive design duffel with a large zippered main compartment including a mesh pocket on the side and a fixed board support on the bottom. The front panel features a pig-snout to store small accessories like keyrings or a carabiner. Open side pocket for easy access. A removable and adjustable shoulder strap with padded shoulder pad for added comfort. Double carry handle with comfortable carry pad.

51 x 25 x 31 cm

Compliance: Cadmium tested
Recommended decoration: Screenprint

New



RICHMOND SHOULDER BAG

PVC.
Exclusive design shoulder bag with zippered front pocket, zippered front compartment and zippered main compartment with organizer and contrast colour lining. Adjustable padded shoulder strap.
31,5 x 18,5 x 40,7 cm

Compliance: Cadmium tested
Recommended decoration: Screenprint



RICHMOND BOWLING BAG

PVC.
Exclusive design sports bag with a large zipper front pocket. Large zipper main compartment with tablet pocket and zipper pocket for accessoires. Comfortable double carry handles.
41 x 19 x 31 cm

Compliance: Cadmium tested
Recommended decoration: Screenprint



RICHMOND 17" LAPTOP BRIEFBAG

PVC.
Exclusive design briefbag with front pocket, zippered mid compartment with organizer and zippered main compartment for 17" laptop with contrast colour lining. Removable and adjustable padded shoulder strap.
32,9 x 15,7 x 43,2 cm

Compliance: Cadmium tested
Recommended decoration: Screenprint



RICHMOND TRAVEL BAG

PVC.
Exclusive design travel bag with zippered front pocket and zippered main compartment with organizer and contrast colour lining. Removable and adjustable padded shoulder strap.
26,7 x 27,3 x 56 cm

Compliance: Cadmium tested
Recommended decoration: Screenprint

RICHMOND



12000701

12000700



RICHMOND FLAPOVER MEDIABAG

PVC.

Exclusive design media bag with zippered front pocket on flap, zippered main compartment under flap with contrast colour lining. Adjustable shoulder strap.

29,5 x 8 x 21 cm

*Compliance: Cadmium tested
Recommended decoration: Screenprint*

MILTON



12012300



ELEVATE

MILTON 14" LAPTOP BACKPACK

600D Polyester and 600D ripstop polyester.

Exclusive design backpack with 2 main zipper compartments, small zippered front compartment and easy access pocket on top. Backpack has a padded back and padded shoulderstraps, possibility to store your 14" laptop in a padded laptop compartment with an extra pocket to store a tablet. Front zippered compartment offers an organisation panel.
28,5 x 16,5 x 46,5 cm

Compliance: Cadmium tested
Recommended decoration: Transfer

12012400



ELEVATE

MILTON 15.4" LAPTOP OUTDOOR BACKPACK

600D Polyester and 600D ripstop polyester.

Exclusive design backpack with 2 main zipper compartments, small front zipper pocket. Backpack has the possibility to store your 15.4" laptop in a padded laptop compartment with an extra pocket to store a 10" tablet, the front compartment is featured with a organisation panel.
30 x 16 x 51,5 cm

Compliance: Cadmium tested
Recommended decoration: Transfer

Avenue's Favourites



ELEVATE

12012500

MILTON SPORTS BAG

600D Polyester and 600D ripstop polyester.

Exclusive design sports bag with adjustable shoulder strap, one of the 2 side pockets is a vented shoe compartment, on the front of the travel bag is a easy acces pocket and a zippered compartment with 2 inner pockets. The main compartment offers a zippered mesh pocket.
54,5 x 25 x 26,5 cm

Compliance: Cadmium tested
Recommended decoration: Transfer



ELEVATE

12012600

MILTON TRAVEL BAG

600D Polyester and 600D ripstop polyester.

Exclusive design large travel bag with adjustable shoulder strap, 2 large side compartments, big front zippered compartment and zipper pocket on top.
72 x 33 x 37 cm

Compliance: Cadmium tested
Recommended decoration: Transfer

REVELSTOKE



11993300



11993301

11993302

ELEVATE

REVELSTOKE LIGHTWEIGHT BACKPACK

75D Polyester diamond ripstop.

Exclusive design foldable backpack high-performance technical materials and YKK zippers with comfortable, adjustable shoulder straps and various additional storage solutions. Packed in an Elevate gift pouch.
29,5 x 16,5 x 44 cm

*Compliance: Cadmium tested
Recommended decoration: Transfer*

11993700



11993701



11993702

ELEVATE

REVELSTOKE 14" LAPTOP BACKPACK

600D Polyester and 75D Polyester diamond ripstop.

Exclusive design backpack. The one-pack solution for daily life and easy outdoor getaways. Foam padding with mid-channel vent system on the back and adjustable padded shoulder straps ensure the highest level of comfort. YKK zippers and Duraflex buckles, padded 14" laptop and 10" tablet compartments and a wealth of storage areas work together to protect your valuables while keeping you perfectly comfortable. Packed in an Elevate gift pouch.
31 x 16 x 45 cm

*Compliance: Cadmium tested
Recommended decoration: Screenprint*



reddot award 2014
winner

11993500



11993501



11993502

ELEVATE

REVELSTOKE WINTERSPORT BACKPACK

600D Polyester and 75D Polyester diamond ripstop.

Exclusive design innovative carrying system that allows for the backpack to be quickly & easily twisted on the body. Versatile wintersport gear carrying system allows a pair of skis or a snowboard to be easily transported using 2 adjustable front face webbing straps. Adjustable padded shoulder straps, quick-access sunglasses pocket at the top, roomy main compartment, organizer compartment, front face pocket plus 2 more side pockets. Quality trims, YKK waterproof zippers and Duraflex buckles. Red Dot winner 2014. Packed in an Elevate gift pouch.
28 x 14 x 50 cm

*Compliance: Cadmium tested
Recommended decoration: Screenprint*

*Avenue's
Favourites*

11993600



11993601



11993602

ELEVATE

REVELSTOKE HIKING BACKPACK

600D Polyester and 75D Polyester diamond ripstop.

Exclusive design backpack metal wireframe, mid-channel ventilation system and heavily padded lumbar and hip areas as well as the fully padded and adjustable shoulder straps, hikers will be able to travel to their next destination in comfort while carrying a significant load. Moreover robust materials, YKK zippers and Duraflex buckles, a wealth of extra storage areas (some of them waterproof) and a stow-away rain cover work together to add the quality touch and ease of use needed on difficult journeys. Packed in an Elevate gift pouch.
32 x 22 x 57,8 cm

*Compliance: Cadmium tested
Recommended decoration: Screenprint*

REVELSTOKE 15.6" LAPTOP SHOULDER BAG MESSENGER

600D Polyester and 75D Polyester diamond ripstop.
 Exclusive design innovative 2-way carrying system suited for either left or right-side use: hanging on the side of the body with long shoulder strap or bike messenger style (high on the back) with short shoulder strap and removeable snap cord stabilizer. Technology pockets: fully padded and secured pocket for 15,6" laptops pocket for tablets (Ipad) multiple storage areas for smaller objects: 4 pockets: 1 zippered quick-access on the flap, 1 zippered under the flap, 1 zippered pocket on the side and 1 elastic micromesh bottle pocket on the side. Quality trims: YKK zippers and Duraflex buckles. Packed in an Elevate gift pouch.
 46 x 15 x 30 cm

Compliance: Cadmium tested
Recommended decoration: Screenprint



11993800



11993801



11993802



11993400



11994000



11993401



11993402



11994001



11994002

REVELSTOKE LIGHTWEIGHT TRAVEL BAG

75D Polyester diamond ripstop.
 Exclusive design foldable travel bag combining high-performance technical materials and YKK zippers with comfortable adjustable carrying straps and various additional storage solutions. Packed in an Elevate gift pouch.
 49 x 24 x 24 cm

Compliance: Cadmium tested
Recommended decoration: Transfer

REVELSTOKE TRAVEL BAG

600D Polyester and 75D Polyester diamond ripstop.
 Exclusive design versatile travel bag will be your perfect companion! Robust PVC-free materials, YKK zippers and Duraflex buckles, padded hand and shoulder carrying solutions, nylux-lined valuables pocket and other various storage areas work together to make your short trip a pleasant one. Packed in an Elevate gift pouch.
 45 x 22 x 28 cm

Compliance: Cadmium tested
Recommended decoration: Screenprint



reddot award 2014
winner



11993901



11993902



11993900



ELEVATE

REVELSTOKE TRAVEL BAG BACKPACK

600D Polyester and 75D Polyester diamond ripstop.

Exclusive design innovative 4-way carrying system: top handles with velcro padded grip area, removeable, adjustable in length shoulder strap with large sliding comfortable shoulder pad, padded backpack straps that click into place when used and hide away in a side pocket when stored, 2 side padded handles, multiple storage areas for smaller objects: 4 pockets: 2 side, 1 front and 1 internal travel size 60x30x30cm is perfect for offshore drilling platform commuters. Quality trims: YKK zippers and Duraflex buckles. Red Dot winner 2014. Packed in an Elevate gift pouch.
60 x 30 x 30 cm

Compliance: Cadmium tested

Recommended decoration: Screenprint



SONIC SLING PACK

420D Polyester and ripstop polyester.

Exclusive design drawstring sling pack with vertical zippered front pocket for easy access. A side zippered valuables pocket and a side beverage pocket of stretch mesh as well as a stretch mesh phone pocket on shoulder strap. Padded mesh backpanel and shoulder strap. Adjustable shoulder strap and reinforced top carry handle.

33 x 11,4 x 43,8 cm

Compliance: Cadmium tested

Recommended decoration: Screenprint



12015603



12015600

11997500



BULLION 17" LAPTOP BACKPACK

420D Polyester.

Exclusive design laptop backpack with padded laptop pocket that fits most 17" laptops, padded tablet sleeve, front zipper pocket with organisation panel and two side pockets.

33 x 23 x 48 cm

Compliance: Cadmium tested

Recommended decoration: Embroidery



12016000



APEX 17" LAPTOP BACKPACK

600D Polyester.

Exclusive design two tone color laptop backpack with an easy-access top loading padded laptop compartment and padded tablet sleeve. Front flap zippered pocket with double buckle closure. Front accessory pocket with mesh pockets and side pockets. Padded adjustable shoulder straps and a reinforced top carry handle.

26,6 x 16,5 x 39,3 cm

Compliance: Cadmium tested

Recommended decoration: Screenprint



ROCKWELL 15" LAPTOP BACKPACK

600D Polyester.

Exclusive design two tone color backpack with dedicated padded laptop compartment fits most 15" laptops. Spacious main compartment with padded tablet pocket, a front compartment with organizer panel and zippered valuables pocket. Two large side pockets. Quilted back panel for extra comfort and lightweight ergonomic shoulder straps with chest strap.
31,7 x 21,5 x 47 cm

Compliance: Cadmium tested
Recommended decoration: Transfer



12016100

11997600



CURB 17" LAPTOP BACKPACK

600D Polyester and 420D polyester.

Exclusive design backpack with padded 17" laptop compartment, tablet pocket, front pocket with two accessory compartments, deluxe organisation panel and two side pockets.
34,3 x 24,1 x 49,5 cm

Compliance: Cadmium tested
Recommended decoration: Transfer

11995100



STRATAGEM 17" LAPTOP BACKPACK

420D Polyester.

Exclusive design laptop bag with dedicated fleece lined top loading laptop compartment fits most 17" laptops, integrated foam panels keep your electronics and other valuables protected, padded iPad/tablet/e-reader pocket. Padded mouse/digital camera pocket. Two zippered side utility pockets, dual side water bottle/accessory holders, deluxe organization panel with zippered stash pocket.
38,1 x 26,7 x 49,5 cm

Compliance: Cadmium tested
Recommended decoration: Transfer

11995600



RENEGADE 15.4" LAPTOP BACKPACK

600D Polyester.

Exclusive design laptop backpack with protected dedicated laptop compartment fits most 15" laptops and select thin 17" laptops. Integrated foam panels keep your electronics and other valuables protected. Padded iPad™/tablet/e-reader pocket.comfort Padded mouse/digital camera pocket. Two zippered side utility pockets and dual side water bottle/accessory holders. Quick access pocket.
33,5 x 25,5 x 49,5 cm

*Compliance: Cadmium tested
Recommended decoration: Transfer*

New



12016200

SLY 13" LAPTOP MESSENGER BAG

600D Polyester.

Exclusive design two tone color messenger with top loading fleece-lined padded laptop compartment fits most 13" laptops. Large main compartment for books, binders and files. Deluxe organization panel under front flap. External zippered accessories pocket and an adjustable webbing shoulder strap with foam shoulder pad.
34,2 x 11 x 24 cm

*Compliance: Cadmium tested
Recommended decoration: Transfer*

11995400



ELGIN 17" LAPTOP CONFERENCE BAG

1680D Polyester.

Exclusive design bag with flapover construction with double lock closure. Interior padded laptop compartment and padded tablet/e-reader sleeve. Easy access zippered pockets for business Essentials. Side beverage/accessory pocket. Attachment strap to fit over most luggage trolley handles. Removable adjustable padded shoulder strap and reinforced top handle.
47 x 10 x 33 cm

*Compliance: Cadmium tested
Recommended decoration: Embroidery*



11995300



CITY CORP 17" LAPTOP CONFERENCE BAG

600D Polyester and 420D Diamond Dobby Nylon.

Exclusive design 17" laptop bag with padded laptop sleeve, audio pocket with headphone exit port, cell phone pocket, adjustable padded shoulder strap and organization panel inside.

45,7 x 15,2 x 33 cm

Compliance: Cadmium tested

Recommended decoration: Screenprint



11995200



ELEMENT 17" LAPTOP CONFERENCE BAG

840D Polyester and 1200D polyester.

Exclusive design bag unzips to expand for greater capacity. Interior padded laptop compartment and padded tablet/e-reader sleeve, organization panel, easy access front stash zippered pocket, rear compartment with file stash, attachment strap to fit over most luggage trolley handles and removable, adjustable padded shoulder strap. Dual reinforced padded carry handles.

45,7 x 15,2 x 33 cm

Compliance: Cadmium tested

Recommended decoration: Embroidery



11997301



11997401



11997300



11997400

HALF DOME DUFFEL BAG

600D Polyester and 420D polyester.

Exclusive design bag with front zipper pocket, side handle and adjustable shoulderstrap.

45,7 x 22,8 x 25,5 cm

Compliance: Cadmium tested

Recommended decoration: Screenprint

CRUNCH DUFFEL BAG

600D Polyester and 420D nylon.

Exclusive design bag with large main compartment, side shoe pocket, side storage pocket, front zipper pocket and adjustable shoulderstrap.

61 x 30,5 x 33 cm

Compliance: Cadmium tested

Recommended decoration: Transfer



12015700



ENDURANCE DUFFEL

420D Polyester.

Exclusive design sports bag with a U-shape zippered large main compartment, zippered front and side pocket and a full sized water bottle pocket. Soft touch molded carry handle and a hide away pack style shoulder strap system and heavily ventilated mesh shoe compartment. Durable abrasion resistant tarpaulin base.

63,5 x 27,9 x 27,9 cm

Compliance: Cadmium tested

Recommended decoration: Transfer



PERSONAL
AND TRAVEL
ACCESSORIES

BY AVENUE



DOVER 3-PIECE FOLDABLE HANGER SET

Ripstop polyester and mesh.

Rethink the way you travel. Discover a world of difference with BRIGHTtravels products that enable you to travel lighter and smarter. This set allows you to hang clothing wherever you go. Lightweight and collapsible, a convenient item to bring on any trip, especially where storage is a challenge. Set includes 3 pieces of hangers stored in a pouch. Exclusive design . 22 x 16 cm

*Compliance: Cadmium tested
Recommended decoration: Screenprint*



13001600



13001500



ATLANTA TRAVEL SET OF GO CLEAN BAGS

Ripstop polyester.

Discover a world of difference with BRIGHTtravels products that enable you to travel lighter and smarter. Set includes includes one zippered carrying bag (size 28 x 24cm) that doubles as storage or use, one shoe bag (26 x 41cm) one laundry bag (40 x 50cm) and one bag (size 29 x 25cm) for all travel accessories or necessities to store for example your iPad or tablet. Includes a guide with 5 packing tips to 'Pack Like A Pro'. Exclusive design. 28 x 23 x 0,3 cm

*Compliance: Cadmium tested
Recommended decoration: Transfer*



BOSTON TRAVEL ORGANIZER

Rethink the way you travel. Discover a world of difference with BRIGHTtravels products that enable you to travel lighter and smarter. This travel organizer stores about anything you need when travelling. Store your electronic accessories and small devices, cosmetics, boarding passes and so on. Includes a small guide with the top 5 packing tips "to Pack Like a Pro". Exclusive design . 25,5 x 6 x 19 cm

*Compliance: Cadmium tested
Recommended decoration: Screenprint*



13001700

New



SPRINGFIELD SET OF 3 PACKING CUBES

Ribstop polyester.

Rethink the way you travel. Be able to pack more and stay organized with packing cubes. Three-piece set includes - one large, one medium, and one small size bag. All three fit within one another for easy, compact storage. Includes a guide with 5 packing tips to 'Pack Like A Pro'. Exclusive design . 43 x 33 x 8 cm

*Compliance: Cadmium tested
Recommended decoration: Transfer*



13000100

New



13001200



PHOENIX PACKABLE FLEECE BLANKET

180 g / m 2 polar fleece and ripstop polyester.

This warm packable fleece blanket is ideal for just about any occasion. The full size blanket (152 x 124cm) folds down to a compact tote (33 x 30cm) with carrying strap and two exterior pockets (33 x 25cm). This perfect blanket for traveling can easily be packed in a suitcase or bag. Includes a small guide with the top 5 packing tips "to Pack Like a Pro". Exclusive design . 33 x 30 cm

*Compliance: Cadmium tested
Recommended decoration: Transfer*





10420201



10420202



10420200

MARKSMAN

0.5W RADAR KEY TORCH

Aluminum and ABS.

A bright 0.5 watt bulb white light. Build in handle at the back which can be used as the push button power switch. Packed in a Marksman gift box. 4-piece LR44 Panasonic button cell batteries included and inserted. Exclusive Design.
 ø 1 x 6,8 cm

*Compliance: WEEE • Battery Directive • RoHS
 Recommended decoration: Engraving*



13400800

MARKSMAN

NANO LOCATOR KEY CHAIN

Aluminum and ABS.

Never lose your keys in the dark with the Locator key chain. The integrated glow in the dark vial will charge itself when exposed to light. Fully charged, the vial will glow a blue light for 6-8 hours. The vial is protected by a high grade aluminum frame. Easily clip your locator with the integrated Click&Go system to your keychain or travel accessory. Packed in a Marksman gift box. Exclusive Design.
 ø 1,3 x 6,9 cm

*Compliance: Cadmium tested
 Recommended decoration: Engraving*

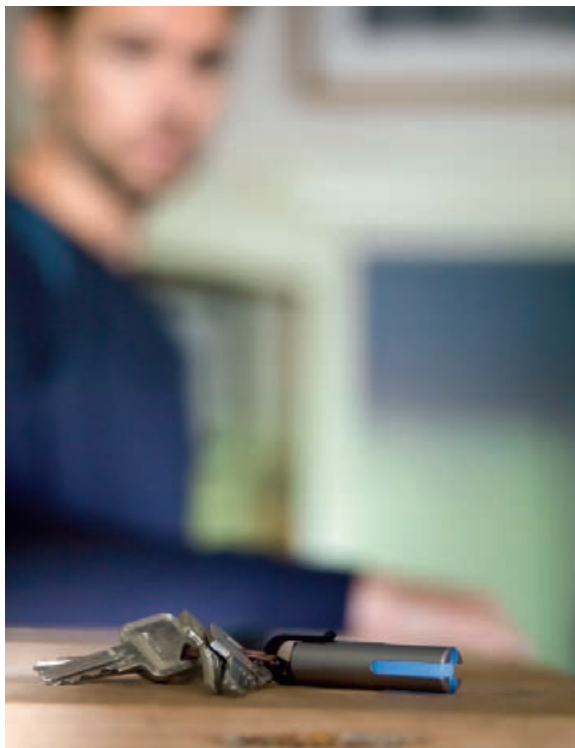



13400700

MARKS MAN

NANO WATERPROOF CONTAINER

Aluminum and ABS.

Protect your necessities on the go with this high grade aluminum container. Designed for improved water resistancy (IPX7 approved). Easily clip your container with the integrated Click&Go system to your key chain or travel accessory. Perfectly fits an AA sized battery, but is for also useful for items like medicine, paper money or matches. Packed in a Marksman gift box. Exclusive Design.

Ø 1,8 x 8,2 cm

Compliance: Cadmium tested

Recommended decoration: Engraving



13400900

MARKS MAN

COBALT KEY CHAIN KNIFE

Stainless steel and Aluminum.

No core mini folding knife with black stainless steel locking blade. Anodized aluminum cover plate at the front with blue detail liner. Integrated Click&Go clip ensures a safe and easy way of carrying your knife. Light weight and compact design (9,8 cm opened). Perfect for everyday use. Packed in a Marksman gift box. Exclusive Design. IF Award winner 2015.

6,6 x 2,3 x 1,4 cm

Compliance: Cadmium tested

Recommended decoration: Engraving



13401000

MARKS MAN

NANO MUSIC SPLITTER AND PHONE STAND

Aluminum and ABS.

Multifunctional phone accessory with a music splitter and phone stand function. The detachable splitter allows two people to listen to the same audio device with their own set of earbuds. Can be used on smartphones, tablets and all other music players with a 3,5 mm audio jack. The phone stand adjusts itself to any size phone and has an improved grip with the integrated rubber pads. Easily clip this item to your keychain or travel accessory with the integrated Click&Go system. Packed in a Marksman gift box. Exclusive Design. IF Award winner 2015.

7,8 x 2,7 x 1,3 cm

Compliance: WEEE • Cadmium tested

Recommended decoration: Engraving

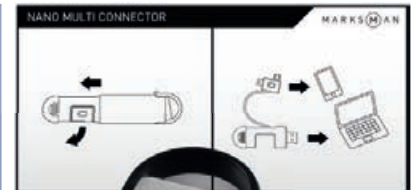

13401100

MARKS MAN

NANO MULTI CONNECTOR

Aluminum and ABS.

Connector cable with micro USB and mini USB to charge and sync your device. Designed for extra comfort and protection with an 84 mm long cable and aluminum case. Easily clip this item to your keychain or travel accessory with the integrated Click&Go system. Packed in a Marksman gift box. Exclusive design.

9 x 3 x 1,5 cm

Compliance: WEEE • Cadmium tested

Recommended decoration: Engraving



12001401



12001400

MARKS  AN

NAVIGATOR PASSPORT WALLET

840D polyester.

Exclusive design passport wallet with zippered closure and several pockets to store your cards and passport. Packed in a Marksman giftbox. Accessories not included.

10 x 1 x 12,3 cm

Compliance: Cadmium tested

Recommended decoration: Transfer



12001301



11971500

MARKS  AN

NAVIGATOR TRAVEL WALLET

High density 600D polyester.

Exclusive design travel wallet with snap button closure zippered side pockets and several pockets to store cards and a passport. Packed in a Marksman giftbox. Accessories not included.

13 x 1 x 23,2 cm

Compliance: Cadmium tested

Recommended decoration: Transfer

MARKS  AN

ODYSSEY RFID WALLET WITH COIN PURSE

Tarpaulin.

Credit cards, passports and other ID's have embedded RFID chips. This exclusive design wallet incorporates a RFID blocking inner layer. It has two note compartments, two slash pockets, four credit card slots and a coin pocket with snap closure. Packed in a Marksman gift box. Accessoires not included.

9,5 x 1,5 x 11,8 cm

Compliance: Cadmium tested

Recommended decoration: Screenprint



13400200

MARKSMAN

ADVENTURER SLIM WALLET

Aluminum and polyester.

Slim down your wallet with this elegant design for easy storage. The wallet can hold up to 10 credit cards. The blue insert can be used as a divider to sort your cards. Paper money can be folded and stored under the elastic band.

Push the blue plate up to access your cards easily. Packed in a Marksman gift box. Exclusive design.

9 x 5,6 x 0,5 cm

Compliance: AZO • Cadmium tested
Recommended decoration: Engraving





11971300

MARKS M AN

ODYSSEY RFID PASSPORT COVER

Tarpaulin.

Credit cards, passports and other ID's have embedded RFID chips. This exclusive design travel wallet incorporates a RFID blocking inner layer. This passport cover has six credit card slots, two storage pockets, a SIM card storage pocket and a pocket to store your passport. Packed in a Marksman gift box. Accessoires not included.
10,5 x 1 x 14 cm

*Compliance: Cadmium tested
Recommended decoration: Screenprint*

*Avenue's
Favourites*



11971400

MARKS M AN

ODYSSEY RFID TRAVEL WALLET

Tarpaulin.

Credit cards, passports and other ID's have embedded RFID chips. This exclusive design travel wallet incorporates a RFID blocking inner layer. The travel wallet has ten credit card slots, two large slash pocket, a passport pocket, a pen loop and a SIM card storage pocket. Packed in a Marksman gift box. Accessoires not included.
11,5 x 1,5 x 22 cm

*Compliance: Cadmium tested
Recommended decoration: Screenprint*



11968700

Avenue

NEWARK DIGITAL LUGGAGE SCALE

ABS plastic and metal.

Portable digital luggage scale. Compact in size to fit in hand luggage. Measures up to 50 kg/110 lbs. Batteries included. 3,7 x 6,1 x 13,1 cm

Compliance: EMC • WEEE • Battery Directive • RoHS • Cadmium tested
Recommended decoration: Padprint



12002100

Avenue

HARVARD WALLET

Split leather.

Exclusive design leather wallet with two money pockets, four card slots and a coin holder. Packed in an Avenue gift box. Accessoires not included. 11,3 x 1,3 x 9 cm

Compliance: AZO • Formaldehyde • PCP • Noncarcinogenic dyestuff • Non-allergenic dyestuff • Cadmium tested
Recommended decoration: Screenprint



12002200

Avenue

HARVARD PASSPORT WALLET

Split leather.

Travel wallet with passport storage slot, six slotted pockets for credit cards and two extra pockets to store your boarding pass, money or personal belongings. Presented in an Avenue gift box. Accessoires not included. 10,5 x 1 x 14 cm

Compliance: AZO • Formaldehyde • PCP • Noncarcinogenic dyestuff • Non-allergenic dyestuff • Cadmium tested
Recommended decoration: Screenprint



12002000

Avenue

HARVARD 3-FOLD TRAVEL WALLET

Split leather.

Exclusive design travel wallet with pockets for a passport, creditcards and other travel documents. Packed in an Avenue gift box. Accessoires not included. 13 x 1,5 x 23 cm

Compliance: AZO • Formaldehyde • PCP • Noncarcinogenic dyestuff • Non-allergenic dyestuff • Cadmium tested
Recommended decoration: Screenprint



12004700

elleven

PROTON TECHNOLOGY ORGANISER CASE

420D polyester.

This unique technology case allows you to house all of your tech products in one convenient place. Elastic allows you to place multiple items of all shapes and sizes in the space that works for you. Ideal for cellphones, MP3 players, flashdrives, cameras and much more. Includes zippered inside pouch. Packed in an Elleven giftbox. Accessories not included.
17,7 x 3,1 x 13,9 cm

*Compliance: Cadmium tested
Recommended decoration: Transfer*



12010500

elleven

VAPOR PASSPORT WALLET

Textured ultrahyde pvc and polyester ripstop.

Get down to business while travelling, with the eleven™ Traverse Collection. RFID Technology encases your belongings to protect against identify theft. Features a quick storage passport slot, mesh ID holder, elastic pen holder, slotted pocket for boarding pass, and additional slots for credit cards. Packed in an Elleven gift box. Accessories not included.
13 x 2 x 16 cm

*Compliance: Cadmium tested
Recommended decoration: Screenprint*



12010800

elleven

VAPOR TRAVEL WALLET

Textured ultrahyde pvc and polyester ripstop.

Streamline your business travelling with the eleven™ Traverse collection. RFID Technology encases your belongings to protect against identify theft. Fully featured travel wallet that has exterior and interior slotted pockets for your boarding pass, passport, and all other travel documents. Includes a privacy mesh ID holder, elastic pen holder, and additional slots for credit cards. Features multiple elastic slots to hold business cards. Packed in an Elleven gift box. Accessories not included.
13 x 2 x 25,5 cm

*Compliance: Cadmium tested
Recommended decoration: Screenprint*



11983300

BALMAIN
PARIS

WALLET

Nappa leather.

Exclusive design wallet with gold coloured accents and pattern lining. The wallet features eight creditcard slots, two slash pockets and two note compartments. Made of genuine nappa leather and presented in a Balmain gift box. Accessories not included.
11,5 x 1,5 x 9,5 cm

Compliance: AZO • Formaldehyde • PCP • Cadmium tested
Recommended decoration: Debossing



11983200

BALMAIN
PARIS

WALLET WITH COIN COMPARTMENT

Nappa leather.

Exclusive design luxury wallet with gold colour accents and pattern lining. Features a button closure coin compartment, four creditcard slots, two slash pockets and two note compartments. Made of genuine nappa leather and presented in a Balmain gift box. Accessories not included.
11,5 x 1,5 x 9,5 cm

Compliance: AZO • Formaldehyde • PCP • Cadmium tested
Recommended decoration: Debossing



11983100

BALMAIN
PARIS

PASSPORT WALLET

Nappa leather.

Exclusive design luxury wallet with gold colour accents and pattern lining ideal for traveling. Equipped with a pocket to store your passport, two slash pockets, six creditcard slots and two slots to store SD/SIM cards. Made of genuine nappa leather and presented in a Balmain gift box. Accessories not included.
10,4 x 0,5 x 14,2 cm

Compliance: AZO • Formaldehyde • PCP • Cadmium tested
Recommended decoration: Debossing



11983000

BALMAIN
PARIS

TRAVEL WALLET

Nappa leather.

This exclusive design luxury wallet with gold colour accents and pattern lining is ideal for traveling. Equipped with a large zipped pocket to store documents, two large slash pockets, six credit card slots and 2 slots for SD/SIM cards. Made of genuine nappa leather and presented in a Balmain gift box. Accessories not included.
11,5 x 1,5 x 22,7 cm

Compliance: AZO • Formaldehyde • PCP • Cadmium tested
Recommended decoration: Debossing

Avenue's
Favourites



10513000

MARKS  AN

OBSERVER ANALOGUE WATCH

Stainless steel and genuine leather.

Exclusive design 3 ATM water resistant watch, 1-piece SR626SW buttoncell battery included and inserted. Packed in a Marksman gift box.
ø 4,2 x 24,7 cm

*Compliance: AZO • Formaldehyde • EMC • PCP • WEEE • Battery Directive
• Noncarcinogenic dyestuff
Recommended decoration: Engraving*



10511800

MARKS  AN



CLASSIC WATCH

Stainless steel and genuine leather

Exclusive design watch, 1-piece SR626SW buttoncell included and inserted, 5 ATM water resistant watch with date and luminous hands. Packed in a Marksman gift box.
ø 4,8 x 24,5 cm

*Compliance: AZO • Formaldehyde • PCP • WEEE • Battery Directive •
Noncarcinogenic dyestuff
Recommended decoration: Screenprint*



10513100

MARKS  AN

OBSERVER CHRONO WATCH

Stainless steel, genuine leather.

Exclusive design watch 3 ATM water resistant watch with date and luminous hands. 1-piece SR920SW buttoncell battery included and inserted. Packed in a Marksman gift box. IF Award winner 2015.
ø 4,2 x 24,7 cm

*Compliance: AZO • Formaldehyde • EMC • PCP • WEEE • Battery Directive
• Noncarcinogenic dyestuff
Recommended decoration: Engraving*



MARKS  AN

CLASSIC CHRONO WATCH

Stainless steel and genuine leather.

Exclusive design 5 ATM water resistant watch with chronograph and luminous hands, 1-piece SR920SW buttoncell included and inserted. Packed in a Marksman gift box.
 ø 4 x 25 cm

*Compliance: AZO • Formaldehyde • PCP • WEEE • Battery Directive •
 Noncarcinogenic dyestuff
 Recommended decoration: Screenprint*



10511900



10512401



10512402

ELEVATE

CARLETON WATCH

Metal and genuine leather.

Exclusive design watch with date function and possibility to engrave on the back of the case, including batteries. Packed in an Elevate gift box.
ø 3,5 x 25,5 cm

Compliance: AZO • Formaldehyde • PCP • WEEE • Battery Directive •
Noncarcinogenic dyestuff
Recommended decoration: Engraving



10512400



SUNGLASSES

BY AVENUE



Avenue's
Favourites



10037602



10037604



10037603



10037601



10037605



10037600



CALIFORNIA SUNGLASSES

Polycarbonate and acrylic.

Exclusive design trendy sunglasses. Classified category 3 sunglasses with UV 400 protection. Polycarbonate frame and acrylic lenses. Includes microfiber pouch for storage which can also be used as cleaning cloth. EN ISO 12312-1 compliant. Presented in a US Basic gift pouch. 18 x 11 cm

Compliance: UV 400 • ISO 12312-1 • Cadmium tested
Recommended decoration: Padprint



10039801



10039802



10039800



FRESNO SUNGLASSES

Exclusive design sunglasses with colored temples. Sunglasses come with a microfiber pouch to store your sunglasses which can also be used as a cleaning cloth. Classified as category 3 sunglasses with UV 400 protection. EN ISO 12312-1 compliant. Presented in a gift box. 14,5 x 6 x 5 cm

Compliance: UV 400 • ISO 12312-1 • Cadmium tested
Recommended decoration: Padprint



10042302



10042301



10042300

New



BAJA SUNGLASSES

Polycarbonate and acrylic.

Sunglasses with fresh color details and trendy colored acrylic lenses. Includes microfiber pouch for storage which can also be used as cleaning cloth.

Classified as category 3 sunglasses with UV 400 protection. Compliant with EN ISO 12312-1. Presented in a gift box. Exclusive design.

15,5 x 5,5 x 3,5 cm

Compliance: UV 400 • ISO 12312-1 • Cadmium tested

Recommended decoration: Padprint



10017401



10017400



BOLD SUNGLASSES

Polycarbonate.

Exclusive design sunglasses with category 3 lenses with UV 400 protection supplied with pouch that can be used as a cleaning cloth. Polycarbonate frame and acrylic lenses.
13,5 x 16,5 x 4,3 cm

*Compliance: UV 400 • ISO 12312-1 • Cadmium tested
Recommended decoration: Padprint*



10028401



10028400



RYDE SUNGLASSES

Polycarbonate.

Exclusive design sunglasses with category 3 lenses with UV 400 protection including cleaning cloth and a hardcase pouch and giftbox. Packed in a Slazenger gift box. Polycarbonate frame and acrylic lenses.
14,4 x 17 x 4 cm

*Compliance: UV 400 • ISO 12312-1 • Cadmium tested
Recommended decoration: Padprint*



10028001



10028000



KENDAL SUNGLASSES

Polycarbonate.

Exclusive design sporty sunglasses category 3 lenses with UV 400 protection supplied with a soft case and cleaning cloth. Packed in a Slazenger gift box. Polycarbonate frame and lenses. 15,5 x 14 x 3,5 cm

*Compliance: Phthalates • UV 400 • ISO 12312-1
Recommended decoration: Padprint*



10008801

PLYMOUTH SUNGLASSES

Polycarbonate.

Exclusive design sunglasses set contains three colour lens options including blue, brown and grey in a EVA box Blue is ideal for low or moderate exposure to bright daylight. The brown colour provides a perceptible increase in contrasts that can improve eye sight quality. Grey is a colour offering excellent natural colour fidelity whatever the sunlight conditions. Lenses are all category 3 and UV 400 protection. Including cleaning cloth. Polycarbonate frame and lenses. 13 x 18 x 7 cm



10008800

*Compliance: UV 400 • ISO 12312-1 • Cadmium tested
Recommended decoration: Engraving*



10001000



BLACKBURN SUNGLASSES

Cupronickel and polycarbonate.

Exclusive design sunglasses category 3 lenses with UV 400 protection, includes hardcase box and cleaning cloth. Packed in a Slazenger gift box. Cupronickel frame and polycarbonate lenses.

17 x 8,3 x 5,3 cm

Compliance: Phthalates • UV 400 • ISO 12312-1 • Cadmium tested

Recommended decoration: Engraving



10030600



NEWTOWN SUNGLASSES

Polycarbonate.

Retro sunglasses with category 3 lenses with UV 400 protection. Including an imitation leather pouch with metal spring closure and cleaning cloth. Packed in a Slazenger giftbox. Polycarbonate frame and acrylic lenses.

13,7 x 15,5 x 4,2 cm

Compliance: Phthalates • UV 400 • ISO 12312-1 • Cadmium tested

Recommended decoration: Padprint



10037401

10037400



10030100



SCUD PEAK SUNGLASSES

Polycarbonate.

Exclusive design sport sunglasses with category 3 lenses and UV400 protection. Polycarbonate frame and lenses. Exclusive Elevate ziplock water repellent translucent pouch and Elevate cleaning cloth included. Packed in an exclusive Elevate giftbox. EN ISO 12312-1 compliance. 17,7 x 10 x 5,2 cm

*Compliance: UV 400 • ISO 12312-1 • Cadmium tested
Recommended decoration: Padprint*

MITCHELL SUNGLASSES

Cupronickel.

Exclusive design polarized sunglasses packed in an imitation leather pouch with metal spring closure. Polarized category 3 lenses and UV 400 protection. Packed in an exclusive design Elevate gift box. Cupronickel frame. 19,4 x 10 x 4 cm

*Compliance: Phthalates • UV 400 • ISO 12312-1 • Cadmium tested
Recommended decoration: Screenprint*



10037500



10037300

10037301



ESTEVAN SUNGLASSES

Brass metal.

Exclusive design polarized sunglasses with metal frame, category 3 lenses and UV400 protection. Brass metal frame and polarized lenses. Exclusive Elevate imitation leather pouch with metal spring closure and Elevate cleaning cloth included. Packed in an exclusive Elevate giftbox. EN ISO 12312-1 compliance. 17,7 x 10 x 5,2 cm

*Compliance: UV 400 • ISO 12312-1 • Cadmium tested
Recommended decoration: Padprint*

CANMORE SUNGLASSES

Polycarbonate.

Exclusive design sport sunglasses with category 3 polarized lenses and UV400 protection. Polycarbonate frame. Exclusive Elevate ziplock water repellent translucent pouch and Elevate cleaning cloth included. Packed in an exclusive Elevate giftbox. EN ISO 12312-1 compliance. 17,7 x 10 x 5,2 cm

*Compliance: UV 400 • ISO 12312-1 • Cadmium tested
Recommended decoration: Padprint*



10028101

10028100

ELEVATE



10030200

ELEVATE

ROBSON SUNGLASSES

Polycarbonate.

Exclusive design. Matt black plastic sunglasses with rubber details on the sides. Polarized category 3 lenses with UV 400 protection. Comes in a hardcase rubber coated pouch with cleaning cloth. Packed in an exclusive design Elevate gift box. Polycarbonate frame.

13,5 x 16,2 x 3,8 cm

Compliance: Phthalates • UV 400 • ISO 12312-1 • Cadmium tested
Recommended decoration: Padprint

ATNA SUNGLASSES

Polycarbonate.

Exclusive design. Matt black plastic sunglasses with metal details on the sides. Polarized category 3 lenses with UV 400 protection. Comes in a hardcase rubber coated pouch with cleaning cloth. Packed in an exclusive design Elevate gift box. Polycarbonate frame.

14 x 16 x 4,2 cm

Compliance: Phthalates • UV 400 • ISO 12312-1 • Cadmium tested
Recommended decoration: Engraving



10030000



ELEVATE

PALMER SUNGLASSES

Polycarbonate.

Exclusive design sportive sunglasses with polarized category 3 lenses with UV 400 protection. Comes in a hardcase rubber coated pouch with cleaning cloth. Packed in an exclusive design Elevate gift box. Polycarbonate frame.

13,5 x 16,5 x 4 cm

Compliance: Phthalates • UV 400 • ISO 12312-1 • Cadmium tested
Recommended decoration: Padprint

LEISURE & SPORTS

BY AVENUE





13401700

ELEVATE

ELLIOTT EMERGENCY PARACORD BRACELET

Plastic and Polyester.

3,1m of heavy-duty paracord (that holds up to 250kg) is woven into a bracelet with a snap buckle that also features a whistle. The cord can be unravelled in an emergency situation and used for building a shelter or carrying gear and wood. The inner filaments can be used as a fishing line or sewing thread. Feature card in EN/FR/DE/IT/ES/NL is added for your convenience. Packed in an Elevate gift box. Exclusive design. ø 8 x 24 x 1,1 x 2,2 cm

*Compliance: AZO • Cadmium tested
Recommended decoration: Padprint*



13401500

ELEVATE

ALVERSTONE MULTIFUNCTION COMPASS

Plastic.

Find your way in style with this compass that includes a whistle and a thermometer. The compass can be used in the night thanks to its glow-in-the-dark markers and when placed on a map the clear window makes it easy to align the compass with the map's north. The exclusively designed double carabiner provides easy attachment. Feature card in EN/FR/DE/IT/ES/NL is added for your convenience. Packed in an Elevate gift box. Exclusive design. 6,3 x 4,5 x 1,3 cm

*Compliance: MSDS • Cadmium tested
Recommended decoration: Padprint*



13401300

ELEVATE

KAIN 10 X 25 MONOCULAR

Plastic and Rubber.

10 x 25 multi-coated optics with ruby anti-glare lenses. Extremely lightweight at 67gr so you can take it with you on every outdoor trip. Rubber textured areas on the body ensures a good grip and the included protective waterproof case can be worn hanging with the use of the exclusively designed double carabiner supplied. Or can be carried on a belt using the belt loop on the back. Also includes a carrying strap and cleaning cloth. Manual in EN/FR/DE/IT/ES/NL is added for your convenience. Packed in an Elevate gift box. Exclusive design. ø 3,2 x 11,3 cm

*Compliance: Cadmium tested
Recommended decoration: Engraving*



13401400

ELEVATE

CRESTON 8 X 40 BINOCULARS

Plastic and Rubber.

8 x 40 wide angle field of view powerful magnification binoculars. Exit pupil 5 ensures good sight even in poor light conditions. Multi-coated optics with ruby anti-glare lenses. Removable rubber lens covers for all 4 lenses which have rubber ties to prevent loss. Also includes protective waterproof case, 2 interchangeable carrying straps and cleaning cloth. At 700gr it is a relatively lightweight companion for your next outdoor adventure. Manual in EN/FR/DE/IT/ES/NL is added for your convenience. Packed in an Elevate gift box. Exclusive design.
18,1 x 15 x 6,3 cm

*Compliance: Cadmium tested
Recommended decoration: Padprint*



13400300

MARKSMAN

DISCOVERY 10 X 25 BINOCULAR

Zinc Alloy.

These compact binoculars enable viewing of an object 10 times closer. The custom made rubber parts and titanium finish gives this item a contemporary design. a 600D polyester pouch with adjustable shoulder strap is added for easy storage. Includes a cleaning cloth. Manual in EN/FR/DE/IT/ES/NL is added for your convenience. Packed in a Marksman gift box. Exclusive design.
11,7 x 7 x 4,7 cm

*Compliance: Cadmium tested
Recommended decoration: Engraving*

New



12366200

Avenue

FIELD ACTIVITY TRACKER WATCH

ABS Plastic.

This activity tracker watch allows you to monitor your activities during the day. It measures the distance, number of steps taken, calories burned and sleep pattern. Free app available for both iOS and Android.

Recommended decoration: Engraving



Slazenger™

5



10026500



6 PANEL FOOTBALL

Latex and PVC.

3 layers football with a 6 panel design with grey and red details allowing a large decoration area. Size 5. Packed in a polybag with printed manual. Exclusive Design.
ø 22 cm

*Compliance: Phthalates • Cadmium tested
Recommended decoration: Padprint*



10027000



32 PANEL FOOTBALL EC16

PU.

New exclusive design 2 layers football with red and blue color details matching most company logos. Size 5. Packed in a polybag with printed manual.
ø 22 cm

Compliance: Phthalates • Cadmium tested



10010000



32 PANEL FOOTBALL

Latex and PVC.

Slazenger football with a cool and modern look. 2 layers, size 5. Packed in a polybag with printed manual. Exclusive Design.
ø 22 cm

*Compliance: Phthalates • Cadmium tested
Recommended decoration: Padprint*



10005200



30 PANEL FOOTBALL

Latex and PVC.

Original Slazenger football with enough imprint space to fit any logo. 3 layers. Size 5. Packed in a polybag with printed manual. Exclusive Design.
ø 22 cm

*Compliance: Phthalates
Recommended decoration: Padprint*



11003700

Avenue

BISHOP 6-IN-1 GAME

Wood.

Natural wood hinged game board features a chess and checkers board on one side and backgammon and tic-tac-toe boards on the other. Includes chess, checkers, backgammon and tic-tac-toe piece, dice, playing cards and instructions. Packed in an Avenue gift box. Exclusive Design.
28 x 17,5 x 7 cm

*Compliance: Formaldehyde • PCP • EN 71 • Cadmium tested
Recommended decoration: Screenprint*

Avenue

TOWER 6-IN-1 GAME

Wood.

Chess, backgammon, cribbage, cards, domino and dices in luxury velvet pouches. Packed in an Avenue gift box. Exclusive Design.
33,5 x 33,5 x 6 cm

*Compliance: Formaldehyde • PCP • EN 71 • Cadmium tested
Recommended decoration: Padprint*



11004400

MARKS  AN

PIONEER CHESS GAME

ABS and Acrylic.

The chess pieces with a black and white executing are made from ABS with a matt finish and a frosted acrylic base. The board is made from black cardboard with high gloss spot UV print. Manual in EN/FR/DE/IT/ES/NL is added for your convenience. Packed in a Marksman gift box. Exclusive Design.
40 x 40 cm

*Compliance: Formaldehyde • PCP • EN 71 • Cadmium tested
Recommended decoration: Screenprint*



11005100

UMBRELLAS

BY AVENUE





10908201

10908200

Avenue

21" ARDEN 3-SECTION AUTOMATIC UMBRELLA

Pongee polyester.

Exclusive design 21" 3-section auto open and auto close umbrella with pinstriped pattern canopy and matching pouch, wooden handle, metal shaft and fiberglass ribs.

ø 98 x 28,5 cm

Compliance: Cadmium tested

Recommended decoration: Screenprint



10908500

Avenue

21" FLOYD 3-SECTION DOUBLE LAYER AUTOMATIC UMBRELLA

Pongee polyester.

Automatic opening and closing. Art deco inspired interior canopy and hardware. Pongee canopy and matching case. Three-section hexagonal folding steel shaft. Delicate rubberized handle with wrist strap. Folds up to only 28 cm long. ø 96 x 28 cm

Compliance: Cadmium tested

Recommended decoration: Screenprint



10908101

Avenue



10908100

27" KENT AUTOMATIC UMBRELLA

Pongee polyester.

Exclusive design 27" automatic umbrella with pinstriped pattern canopy and matching pouch, wooden handle and wooden shaft and fiberglass ribs.

ø 119 x 98,5 cm

Compliance: Cadmium tested

Recommended decoration: Screenprint



10908400

Avenue

27" CARDEW DOUBLE LAYER AUTOMATIC UMBRELLA

Pongee polyester.

Umbrella with 2 layers canopy with art deco inspired interior canopy. Automatic opening. Pongee canopy and matching case. Steel shaft. Delicate rubberized handle. Packed in a Avenue gift pouch. ø 119 x 96 cm

Compliance: Cadmium tested

Recommended decoration: Screenprint



10908700



10908701



10908702

Avenue

23" SPARK AUTO OPEN UMBRELLA

Pongee polyester.

Automatic opening 23" umbrella. Pongee canopy and matching pouch, color pop fiberglass shaft and fiberglass ribs. Color matching stitching on umbrella closure strap. Exclusive design.

Compliance: Cadmium tested
Recommended decoration: Screenprint



10906401



10906400



10906403



10906402



10907202



10907201



10907200

MARKS (M) AN

MARKS (M) AN

21.5" TRAVELER 3-SECTION AUTOMATIC UMBRELLA

Pongee polyester.

Exclusive design automatic open 3-section umbrella. Metal black shaft, fiberglass ribs and rubber coated plastic handle. Supplied with matching canopy colour pouch. Folds up to 31cm.
ø 98 x 30,8 cm

Compliance: Cadmium tested
Recommended decoration: Screenprint

23" ARCH AUTOMATIC UMBRELLA

Pongee polyester.

Exclusive design umbrella with automatic open function. Metal shaft and ribs. Special design handle to easily hang the umbrella on the table. Rubbercoated crook handle with aluminium detail. Matching colour pouch.
ø 102 x 86 cm

Compliance: Cadmium tested
Recommended decoration: Screenprint



10906500



10906501



10906502



10906504



MARKS (M) AN

23" SQUARE AUTOMATIC UMBRELLA

Pongee polyester.

Unique and exclusive design square shaped umbrella. Automatic opening. Contrast color interior canopy and black color pouch. Fiberglass shaft and ribs and rubberized handle.
ø 101 x 83 cm

Compliance: Cadmium tested
Recommended decoration: Screenprint





10906600



10906601

MARKS  AN

27" A8 AUTOMATIC UMBRELLA WITH LED LIGHT

Pongee polyester.

Exclusive design automatic open umbrella with bright LED light in handle. 3 batteries included. Fibreglass shaft and ribs. Including storage pouch.
 ø 117 x 93 cm

*Compliance: Battery Directive • RoHS • Cadmium tested
 Recommended decoration: Screenprint*



10907402



MARKS  AN

30" HALO UMBRELLA

Pongee polyester.

Exclusive design umbrella with metal shaft and fiberglass ribs and rubber coated plastic handle. Supplied with canopy colour matching pouch.
 ø 130 x 100,5 cm

*Compliance: Cadmium tested
 Recommended decoration: Screenprint*



10907401



10907403



10907400

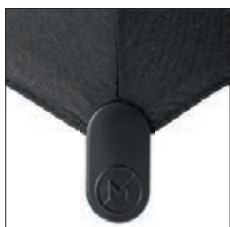

10908000

MARKS  AN

27" TWIST AUTOMATIC UMBRELLA

Pongee polyester.

First umbrella in the market that opens by twisting the handle. Exclusive design automatic open umbrella with matching pouch and fiberglass shaft and ribs. Equipped with eye savers. Rubber coated plastic handle with brushed aluminum cover.
ø 122 x 91,5 cm

Compliance: Cadmium tested
Recommended decoration: Screenprint



10900100



10900105



10900106

23" CHESTER AUTOMATIC UMBRELLA

Polyester.

Exclusive design umbrella with contrasting color details on canopy, handle and umbrella tie. Metal shaft and ribs and black rubber coated handle. ø 97 x 83,5 cm

Compliance: Cadmium tested

Recommended decoration: Screenprint

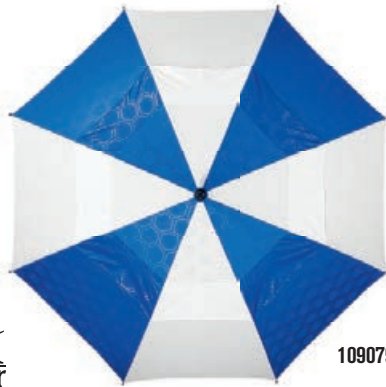

10907902



10907900



10907901

27" CHAMPIONS AUTOMATIC VENTED UMBRELLA

Polyester.

Exclusive design 27" umbrella with large vented canopy, rubberized handle. All fiberglass lightning resistant construction. Includes carrying case with shoulder strap. ø 120 x 90 cm

Compliance: Cadmium tested

Recommended decoration: Screenprint



10901905



10901907

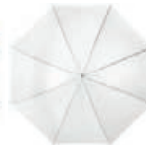

10901903



10901901



10901900

30" WINNER UMBRELLA

Polyester.

Exclusive design 30" umbrella with metal shaft and ribs. Equipped with an EVA handle. ø 130 x 101,5 cm

Compliance: Cadmium tested

Recommended decoration: Screenprint



10900304



10900300



10900305



10900307



30" CARDIFF DOUBLE LAYER STORM UMBRELLA

Nylon.

Exclusive design storm umbrella with double layer material, fiberglass ribs and shaft. This construction allows the wind to blow through the umbrella to prevent the umbrella from collapsing.
ø 127 x 97 cm

*Compliance: Cadmium tested
Recommended decoration: Screenprint*



10907802



10907800



10907801



30" CUBE VENTED UMBRELLA

Polyester.

Exclusive design 30" umbrella with vented square canopy, rubberized handle. All fiberglass lightning resistant construction. Includes carrying case with shoulder strap.
ø 108 x 98 cm

*Compliance: Cadmium tested
Recommended decoration: Screenprint*



10905900



10905901



10905902



10905903



10905904



32" YORK DOUBLE LAYER STORM UMBRELLA

Nylon.

Exclusive design large storm umbrella made from double layered material with fiberglass ribs and shaft. Special construction allows the wind to blow through the umbrella without it turning inside out.

ø 142 x 103 cm

Compliance: Cadmium tested

Recommended decoration: Screenprint



10908600



10908601



32" BRIGHTON AUTOMATIC UMBRELLA

Polyester.

Exclusive design classic style umbrella with contrasting edge and matching style pouch. Metal shaft and ribs. Imitation leather hook handle with contrasting trim.

ø 102 x 85,5 cm

Compliance: Cadmium tested

Recommended decoration: Screenprint



BALMAIN
PARIS

21" 3-SECTION UMBRELLA

Polyester.

Exclusive design 3-section umbrella with contrasting edge and matching style pouch with metal shaft and ribs. Imitation leather handle with wrist strap.

Folds up to only 25cm long.

ø 95 x 25,5 cm

Compliance: Cadmium tested

Recommended decoration: Screenprint



BALMAIN
PARIS

21" 3-SECTION AUTOMATIC UMBRELLA

Pongee polyester.

Automatic opening and closing. Vented pongee canopy. Matching pongee case. Three-section hexagonal folding steel shaft. Windproof frame with fiberglass ribs. Rubberized handle with wrist strap. Folds up to only 28cm long.

ø 101 x 28 cm

Compliance: Cadmium tested

Recommended decoration: Transfer



10904401



10904402



10904400



19984992



19984990

BALMAIN
PARIS

23" UMBRELLA

Polyester.

Exclusive design classic style umbrella with contrasting edge and matching style pouch. Metal shaft and ribs. Imitation leather hook handle with contrasting trim.

ø 102 x 85,5 cm

Compliance: Cadmium tested

Recommended decoration: Screenprint



19984981



10906900



19984980

BALMAIN
PARIS

27" UMBRELLA

Nylon.

Exclusive design classic style umbrella with black color metal shaft, ribs and wooden hook handle. Supplied with matching canopy colour pouch .

ø 120 x 98 cm

Compliance: Cadmium tested

Recommended decoration: Screenprint

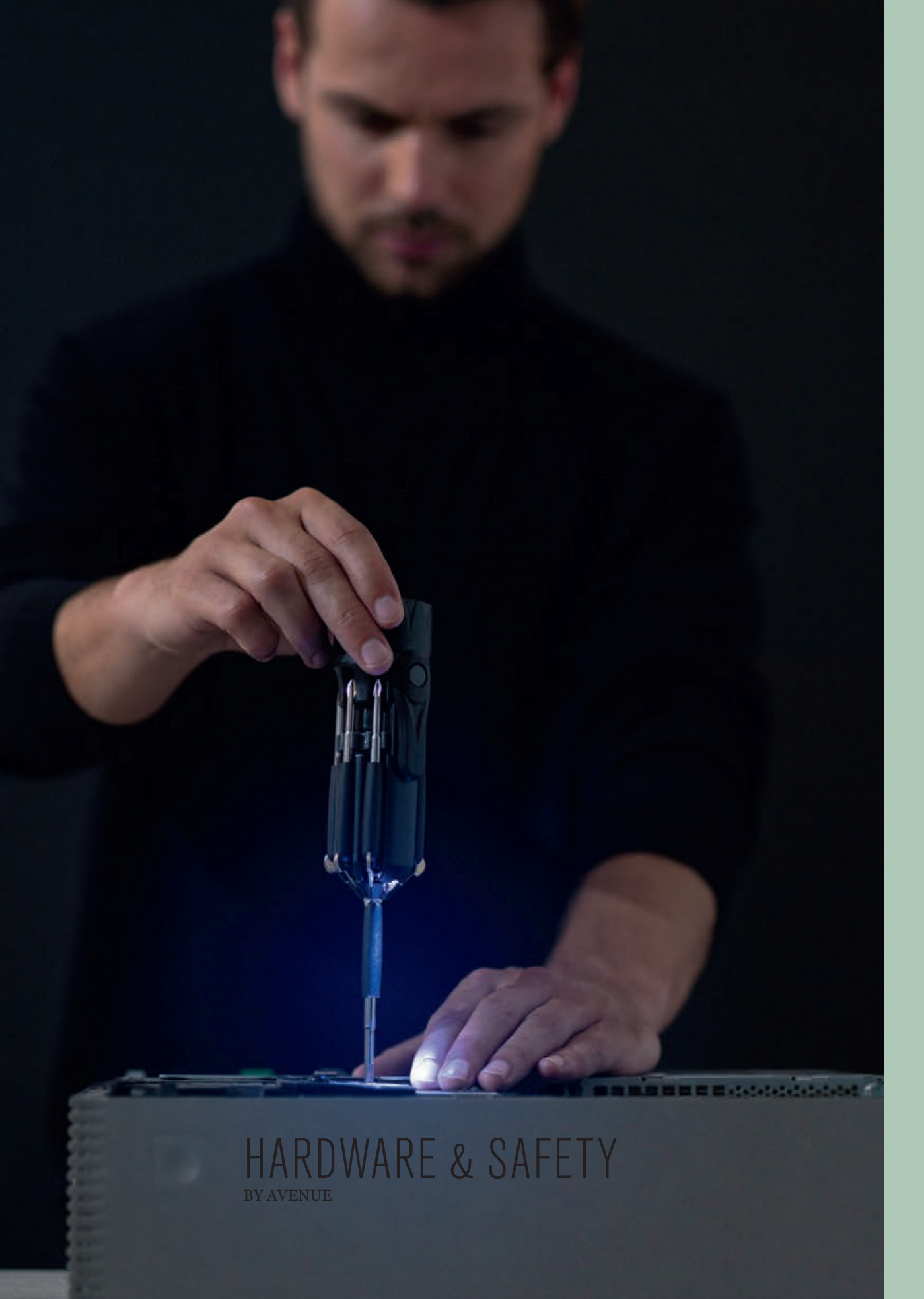

HARDWARE & SAFETY

BY AVENUE

New



10424000

Avenue

BOTTLE OPENER FLASHLIGHT

Metal.

Be the life of the party with this 9 LED bottle opener and flashlight. Push-button on/off. Includes 3 AAA batteries.
ø 2,5 x 10 cm

Compliance: EMC • Battery Directive • RoHS
Recommended decoration: Engraving

New



10424100

Avenue

CARABINER HOOK FLASHLIGHT

Metal.

Take this compact 9 LED carabiner hook flashlight with you anywhere. Perfect for storing in your car, in your bag or taking along on a camping trip. Push on/off button. 3 AAA batteries included.
ø 2,5 x 9 cm

Compliance: EMC • Battery Directive • RoHS
Recommended decoration: Engraving



10418700



1W LIGHTHOUSE TORCH

Aluminum, Metal and Silicon.

Made of an aluminum body with red silicon rings the lighthouse torch makes a strong impression. It can be used as a 1 watt flashlight with a build-in zoom function. With the pull-out function it becomes a lantern for maximum light exposure. The metal hook makes it easy to hang up the lighthouse for different situations. Packed in a 707 gift box. Batteries included and inserted. Exclusive Design.
ø 3,7 x 10,2 cm

Compliance: WEEE • Battery Directive • RoHS
Recommended decoration: Screenround



1W RADAR POCKET TORCH

ABS and Aluminum.

Aluminum torch with a powerful 1 watt bulb white light with a frosted lens and a push button power switch at the back. Integrated clip next to the push button. Packed in a Marksman gift box. 3-piece AAA Panasonic penlite batteries included and inserted. Exclusive Design.
 ø 2,8 x 11,7 cm

Compliance: WEEE • Battery Directive • RoHS
Recommended decoration: Engraving



1W VECTOR TORCH

Aluminum and TPR.

Aluminium torch with powerful 1 watt LED white light with a frosted lens and a push button power switch at the back. Packed in a Marksman gift box. 2-piece AAA Panasonic penlite batteries included and inserted. Exclusive Design.
 ø 1,8 x 15,2 cm

Compliance: WEEE • Battery Directive • RoHS
Recommended decoration: Engraving



1W ORBIT TORCH

Aluminum.

1 watt LED white light aluminium torch with frosted lens and twist action activation. Packed in a Marksman gift box. 2-piece AA Panasonic penlite batteries included and inserted. Exclusive Design.
 ø 2,1 x 15,8 cm

Compliance: WEEE • Battery Directive • RoHS
Recommended decoration: Engraving



MARKSMAN



3W POLARIS TECHNICAL TORCH

Aluminum.

3 watt LED white light aluminium torch with frosted lens and push button activation. Belt clip and strap added. Packed in a Marksman gift box. 3-piece AAA Panasonic penlite batteries included and inserted. Exclusive Design. ø 4 x 18 cm

*Compliance: EMC • WEEE • Battery Directive • RoHS
Recommended decoration: Engraving*



10421300

10421301

10421302



10420700

10420600

MARKSMAN

APOLLO GIFT SET

ABS, Aluminum and Stainless steel.

Compact gift set with the Radar key chain torch that comes with a 0,5 Watt light and handle which can be used as a push button power switch. The Triton mini pocket knife with 12 functions is added to accompany the torch and to make this a functional and desirable set. Packed in a Marksman gift box. Batteries included. Exclusive Design. 8,6 x 10 x 2,3 cm

*Compliance: WEEE • Battery Directive • RoHS
Recommended decoration: Engraving*

MARKSMAN

ORION GIFT SET

ABS, Aluminum and Stainless steel.

With the combination of the Terra knife and Radar pocket torch both executed in a black version the Orion gift set has best of both worlds. The terra knife with it's stainless steel blade and liner lock. The Radar pocket torch with a powerful 1 watt light and push button power switch at the back. Packed in a Marksman gift box. Batteries included. Exclusive Design. 16,5 x 11,5 x 4,5 cm

*Compliance: WEEE • Battery Directive • RoHS
Recommended decoration: Engraving*

MARKSMAN

TERRA FOLDING KNIFE

Aluminum and Stainless steel.

Stainless steel blade with an aluminum handle. Features a liner lock to safely hold the open blade in place. Packed in a Marksman gift box. Exclusive Design.

18 x 1,4 x 2,7 cm

Compliance: Cadmium tested
Recommended decoration: Engraving



10414901



10414900

MARKSMAN

COBALT FOLDING KNIFE

G10 and Stainless steel.

No core featured knife with a 420 stainless steel blade with black finish and G10 handle. Features a liner lock to safely hold the open blade in place. Belt clip at the back with the engraved Marksman logo. Packed in a Marksman gift box. Exclusive Design.

12 x 3,5 x 1,1 cm

Compliance: Cadmium tested
Recommended decoration: Engraving



10421200



10415100

MARKSMAN

OZONE CERAMIC KNIFE

Aluminum and Ceramic.

Black ceramic folding knife with champagne coloured handle, combining urban design with functionality. As ceramic has a long hardening process, the blade is even harder and sharper than steel. Packed in a Marksman gift box. Exclusive Design.

11,3 x 3 x 1,2 cm

Compliance: Cadmium tested
Recommended decoration: Engraving



10415300



10415500

MARKS  AN

MARKS  AN

TRITON 11-FUNCTIONS MINI POCKET KNIFE

Aluminum and Stainless steel.

Stylish compact 11 function pocket knife. Packed in a Marksman gift box. Exclusive Design.
6,2 x 1 x 2,1 cm

Recommended decoration: Engraving

MAGMA 10-FUNCTIONS MINI MULTI TOOL.

ABS and Stainless steel.

10 function mini tool packed in a Marsman gift box. Batteries included. Exclusive Design.
7 x 3,1 x 1,2 cm

*Compliance: WEEE • Battery Directive • RoHS
Recommended decoration: Padprint*



10420300



10415200

MARKS  AN

MARKS  AN

HALO 12-FUNCTIONS KEY CHAIN TOOL

Stainless steel and Tarpaulin.

Compact and functional are the words to describe the Halo key chain tool. With 12 different functions it's a must have for every day users. Feature card is added for your convenience. Packed in a tarpaulin pouch inside a Marksman gift box. Exclusive design.
8 x 3,3 x 0,4 cm

*Compliance: Cadmium tested
Recommended decoration: Engraving*

NEPTUNE 11-FUNCTIONS POCKET KNIFE

Aluminum and Stainless steel.

11 function pocket knife. Packed in a Marksman gift box. Exclusive Design.
9,4 x 2,3 x 2,8 cm

Recommended decoration: Engraving



13400600

MARKS M AN

MERIDIAN ICE SCRAPER

Aluminum and ABD with soft touch.

Handheld ice scraper with a soft touch handle to give you extra grip. Use the scraper to remove the ice and the silicon whiper to clean your windshield. Packed in a Marksman gift box. Exclusive Design.

21,7 x 11,9 x 5,4 cm

*Compliance: Cadmium tested
Recommended decoration: Padprint*



13400500

MARKS M AN

EXOS CAR EMERGENCY TOOL

Aluminum and ABS with soft touch.

Compact 2-in-1 tool with a seat belt cutter integrated in the soft touch handle and a window breaker which is spring loaded and can be activated by pushing the item against the window. Packed in a Marksman gift box. Exclusive Design. IF Award winner 2015.

ø 3,4 x 16,2 cm

*Compliance: Cadmium tested
Recommended decoration: Engraving*



13400400

MARKS M AN

PEGASUS MULTIFUNCTION 1W CAR EMERGENCY TORCH

Aluminum and Silicon.

This product is your companion during a car emergency. Take off the silicon handle to access the window hammer and safety belt cutter. the built-in magnets are protected by the silicon cover when attaching the product to vehicles. Including a regular 1W torch, a side light in white and red which can be used as a working light (white lights using 10 LEDs) or a flash emergency signal (red lights using 10 LEDs). Manual in EN/FR/DE/IT/ES/NL is added for your convenience. Packed in a Marksman gift box. Batteries included and inserted. Exclusive design. IF Award winner 2015 and Red Dot winner 2015.

ø 7 x 24,3 cm

*Compliance: EMC • WEEE • Battery Directive • RoHS
Recommended decoration: Engraving*



13401800

ELEVATE

DELTAFORM KNIFE WITH CARABINER

Stainless steel.

Single blade folding knife with a stainless steel titanium coated handle and blade with an integrated saw. Easy gripping area on the handle. It's equipped with an integrated carabiner and clip which makes this item easy to carry. For added safety it features a liner lock to safely hold the open blade in place. Feature card in EN/FR/DE/IT/ES/NL is added for your convenience. Packed in an Elevate gift box. Exclusive design.
11,2 x 1,3 x 3 cm

Recommended decoration: Padprint



13401600

ELEVATE

NORQUAY 17-FUNCTIONS BIKE TOOL

Aluminum and Stainless steel.

With 17 tools and functions you have everything you need while facing bike problems. This work tool has 6 box wrenches added in different sizes. The aluminum plates have textured areas for the perfect grip. Feature card in EN/FR/DE/IT/ES/NL is added for your convenience. Packed in an Elevate gift box. Exclusive design.
10,3 x 3,3 x 2,9 cm

Recommended decoration: Engraving



13401900

ELEVATE

HAIIDUK 13-FUNCTIONS POCKET KNIFE

Aluminum and Stainless steel.

This compact 13-functions pocket knife is the ideal companion for outdoor activities. Featuring an integrated folding carabiner and blade, both finished with a titanium coating. The textured surface of the aluminum back plate ensures a firm grip. Feature card in EN/FR/DE/IT/ES/NL is added for your convenience. Packed in an Elevate gift box. Exclusive design.
9 x 1,9 x 2,9 cm

Recommended decoration: Padprint



13402100

ELEVATE

PIKA MULTIFUNCTION LIGHT

ABS Plastic and Elastic.

This versatile light has 3 ultra bright LED's with 4 light modes that ensure optimal light level. It can be used as an arm running light, a head visibility light or a front bike light. The elastic band and cord as well as the spring clip ensures endless attachment possibilities. Manual in EN/FR/DE/IT/ES/NL is added for your convenience. Packed in an Elevate gift box. Batteries included and inserted. Exclusive design.
 4,5 x 4,9 x 2,2 cm

Compliance: AZO • EMC • WEEE • Battery Directive • Noncarcinogenic dyestuff • RoHS
Recommended decoration: Padprint



10424500

ELEVATE

WATERPROOF IPX-4 CREE R3 FLASHLIGHT

Metal.

Waterproof mini torch with 3W CREE LED light. Features 3 light modes: 100%, 50% and quick flashing light. Incl. black lanyard. Battery included and inserted.
 ø 1,9 x 9,7 cm

Compliance: Battery Directive • RoHS
Recommended decoration: Engraving



13402000

ELEVATE

WEYBURN 3W TORCH

Aluminum.

Dual use torch/lantern has super bright 3W CREE LED with light 4 light modes and zoom function. The lantern can be used either standing or hanging using the exclusively designed double carabiner. Includes removeable metal spring with front and back positioning. Manual in EN/FR/DE/IT/ES/NL is added for your convenience. Packed in an Elevate gift box. Batteries included and inserted. Exclusive design.
 ø 3,2 x 12,1 cm

Compliance: EMC • WEEE • Battery Directive • RoHS
Recommended decoration: Engraving



10424200

ELEVATE

DYNAMO LANTERN SPOTLIGHT

ABS Plastic.

Dynamo high power LED flashlight, spotlight, and lantern with 5 LED.5 watts. Push-button on/off. Wind up one minute and LEDs will light up for 60 minutes, if charged by AC/DC adapter will continuously work for four hours. Hanging double hook. Adjustable handle to hold as a lantern or spotlight.

Compliance: Battery Directive • RoHS



13403000



10424300

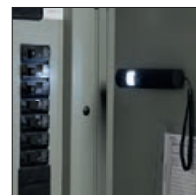

STAC

9 LED TORCH

ABS plastic.

Use this compact torch to promote a safety program. Includes 9 super bright LED lights (approximately 30 lumens). Push-button power switch on bottom. Provides up to 16 hours of continuous light on one set of batteries. Nylon strap for easy carrying. Packed in a STAC gift box. Batteries included and inserted. Exclusive design.

ø 2,9 x 9,8 cm

Compliance: WEEE • Battery Directive • RoHS

Recommended decoration: Padprint

STAC

MINI GRIP SLIM AND BRIGHT MAGNETIC LED FLASHLIGHT

ABS Plastic.

At just the right size, this spray rubber mini flashlight is slim and bright with 3 modes. The first mode a 4 LED flashlight, the second mode a 6 LED flashlight and the third mode is both on at once. Magnetic back for easy storage or for hands free use when attached to metal surfaces. Nylon carrying strap. Push button on/off. 29 lumen. 2 AAA batteries included.

Compliance: Battery Directive • RoHS



13403100

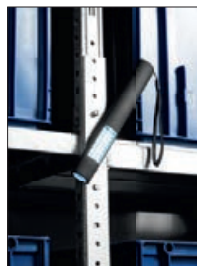

13402700

STAC

8 LED TORCH

Aluminum.

8 LED torch with aluminum body with it's head in the shape of a bolt. Push-button on/off at the bottom. Nylon wrist strap for easy carrying. Packed in a STAC gift box. Batteries included and inserted. Exclusive design.

ø 2,9 x 9,8 cm

Compliance: WEEE • Battery Directive • RoHS

Recommended decoration: Padprint

STAC

MAGNETIC 28 LED TORCH

ABS plastic with soft touch coating.

Slim and magnetic torch which has three modes. The first mode is a 4 LED flashlight, the second mode is the 24 LED light, and the third mode is both on at once. Magnetic back for easy storage or for placement against metal surfaces when in use. Push button on/off. Nylon carrying strap. Packed in a STAC gift box. Batteries included and inserted. Exclusive design.

20 x 2,2 x 2,1 cm

Compliance: WEEE • Battery Directive • RoHS

Recommended decoration: Engraving

New



13418000

STAC



9 LED TORCH

Metal and Rubber.

Handy bright 9 LED designed torch with black rubber handle and metal head. Packed in a STAC gift box. Batteries included and inserted. Exclusive Design.

ø 2,5 x 11 cm

Compliance: EMC • WEEE • Battery Directive • RoHS

Recommended decoration: Engraving

STAC

9 PIECE RATCHETING SCREWDRIVER SET

Metal.

Compact multi-bit ratcheting screwdriver set. The set includes 4 slotted bits (3,4,5,6MM) and 4 Phillips bits (PH0,1,2,3). Packed in a STAC gift box.

Recommended decoration: Padprint

New



10424900

New



10424400

STAC



MAGNETIC TELESCOPIC PICK-UP TOOL LIGHT

Metal.

Tool with magnetic telescopic antenna including light to find small metal objects/ parts in places that are hard to reach or dark. Packed in a STAC gift box.

Recommended decoration: Engraving



13402900

STAC

SPIDEY 8-IN-1 SCREWDRIVER WITH TORCH

ABS plastic.

Perfect to keep this tool around the house, it has 1 LED light, 3 Phillips heads, 3 flat heads, and a small eye glass tool with screw on cap. Press the button once for the flashlight, and again for the LED to illuminate the tools. Packed in a STAC gift box. Batteries included and included. Exclusive design.
 ø 4,5 x 13,8 cm

Compliance: EMC • WEEE • Battery Directive • RoHS
 Recommended decoration: Padprint



13418200

STAC

16- FUNCTIONS MULTI TOOL

ABS and Stainless steel.

High quality rubber edged 16-functions tool includes 6 Hex keys (#2, #2,5, #3, #4, #5, #6), 4 Wrenches (8mm, 10mm, 15mm, 14GE), Adapter, Cross-head screwdriver, Slotted screwdriver and 3 Sockets (#8, #9, #10). Packed in a STAC gift box. Exclusive Design.
 4,5 x 8,8 x 2,5 cm

Compliance: Cadmium tested
 Recommended decoration: Padprint



13418100

STAC

MULTI FUNCTION MEASURER

ABS.

Features a measuring tape, laser and 2 levels. The perfect 4-in-1 combination. Packed in a STAC gift box. Batteries included and inserted. Exclusive Design.
 2,8 x 15 x 5,9 cm

Compliance: EMC • WEEE • Battery Directive • EN 60825 • RoHS
 Recommended decoration: Padprint



13403200

STAC

25- PIECE TIRE SHAPE TOOL SET

ABS plastic.

25-piece tool set includes a mini tape measurer, Phillips head screw driver, flat head screw driver, 9 bits with adaptor (4 Phillips heads, 2 flat heads, and 3 Hex heads), 3 Hex wrenches, 5 sockets (5-9mm), needle nose pliers, screw driver handle and adaptor for bits and a convenient case. Packed in a STAC gift box. Exclusive design.

ø 16 x 6 cm

Compliance: Cadmium tested

Recommended decoration: Padprint



13402600

STAC

3-IN-1 CAR EMERGENCY TOOL

ABS plastic with soft touch coating.

Three-in-one emergency safety tool includes hammer to break through glass, seatbelt cutter and dynamo flashlight. Crank handle to generate power. No external batteries needed. Rubber design handle for easy gripping. Packed in a STAC gift box. Build-in rechargeable battery. Exclusive design.

15,3 x 8 x 3,2 cm

Compliance: EMC • WEEE • Battery Directive • MSDS • RoHS

Recommended decoration: Padprint

New



10424800

STAC

16-IN-1 FLASHLIGHT LASER MULTI-TOOL

ABS plastic and Stainless Steel.

16-in-one multi-tool features 4 piece socket set, socket connecting rod, bottle opener, knife, saw, 2 Phillips head screwdrivers, 2 straight screwdrivers, hex key, punch, 0.75W LED flashlight and laser pointer. Packed in a STAC gift box.

12,5 x 4,5 x 4,5 cm

Recommended decoration: Padprint



13402500

STAC

3-IN-1 DIGITAL TIRE GAUGE WITH LIGHT

ABS plastic.

The small flashlight (works 24 hours when fully charged) and LED light allow the user to check the tire pressure in dark or dimly lit places. Capacity 10 BAR (accommodates cars/campers/trucks). Press "ON" button to select PSI, BAR, KPA and KG, CM2 setting. Packed in a STAC gift box. Batteries included and inserted. Exclusive design.

17 x 4,7 x 2,4 cm

Compliance: EMC • WEEE • Battery Directive • RoHS

Recommended decoration: Padprint



STAC

PB-1400 CAR POWERBANK AND TORCH

ABS plastic.

Power up anytime and anywhere with this 1400 mAh charger and torch. Plugs into your cigarette lighter or computer to charge the built-in battery to use as a powerbank, or plug in your phone to charge while driving. To charge the built-in battery by car, allow 4-5 hours to fully charge. LED torch has three modes: standard flashlight, slow flashing, or rapid flashing for emergencies. Magnet located at the base to secure to metal surfaces or vehicles to signal in case of emergencies. 180 degree rotation to angle flashlight or for better access when charging. Packed in a STAC gift box. Build-in rechargeable battery. Exclusive design.
 ø 2,9 x 14,4 cm

*Compliance: EMC • WEEE • Battery Directive • MSDS • RoHS
 Recommended decoration: Padprint*



STAC

MULTIFUNCTION CAR EMERGENCY TORCH

ABS plastic.

Illuminates up to 200m. Includes window hammer, safety belt cutter, and built-in magnet for attaching to vehicles. Lasts up to 36 hours when used as a torch (using one super bright LED) or up to 48 hours when used to flash red emergency signal (using 9 LEDs). Packed in a STAC gift box. Batteries included and inserted. Exclusive design.
 19,4 x 6,7 x 4,1 cm

*Compliance: EMC • WEEE • Battery Directive • RoHS
 Recommended decoration: Padprint*

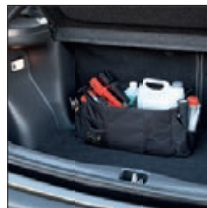

STAC

TRUNK ORGANISER

600D polyester.

Collapsible interior can be used as a single compartment or divided into 2.5 exterior pockets. Velcro strips on bottom secure to car floors and carpets.
 46 x 21 x 22 cm

Recommended decoration: Screenprint



10412200

STAC

BACK SEAT ORGANISER WITH TABLET COMPARTMENT

210D polyester.

The tablet compartment can be closed by velcro to keep the tablet in place. Several handy pockets are added to store your belongings. A drawstring is added at the bottom to tighten the product to the back seat of your car.

54,4 x 44 x 2 cm

Recommended decoration: Screenprint



10416900

STAC

ACCORDION TRUNK ORGANIZER

600D polyester.

This trunk organizer keeps your car clean and organized and folds neatly to store when not in use. 600D polyester material with two outer pockets for extra storage and two inner compartments. Padded handles for easy carrying. Packed with a STAC hangtag. Exclusive design.

60 x 36 x 31 cm

Compliance: Cadmium tested

Recommended decoration: Screenprint



13402200

STAC

6- PIECE CAR WASH KIT

600D polyester.

Give your car a bath with this 6-piece car wash kit. Includes a sturdy 9L collapsible bucket with metal handle, micro fiber cloth, sponge, wash mitt, squeegee and convenient carrying case with handle. The 600D polyester case has a pocket for storing other items. Packed with a STAC hangtag. Exclusive design.

ø 24 x 22,2 cm

Compliance: AZO • Cadmium tested

Recommended decoration: Screenprint



13402300



10417400

DUNLOP

WRIST BAND WITH MAGNETS

600D polyester.

The "six pack" of magnets will help you store nails and bits while doing construction work. The wrist band can be put on via the velcro strap. Packed in a Dunlop gift box. Exclusive Design.
27,6 x 7,3 x 0,6 cm

Compliance: AZO • Formaldehyde • Noncarcinogenic dyestuff • Cadmium tested

Recommended decoration: Transfer



10401900

DUNLOP

15-FUNCTIONS POCKET KNIFE

ABS and Stainless steel.

High quality 15-functions knife in a 600D polyester pouch. Packed in a Dunlop gift box. Exclusive Design.
8,5 x 2 x 3 cm

Compliance: Cadmium tested

Recommended decoration: Padprint



10405200

DUNLOP

18-FUNCTIONS MULTI TOOL

ABS and Stainless steel.

18-functions tool with a storage pouch. Packed in a Dunlop gift box. Exclusive Design.
12 x 5,5 x 4 cm

Compliance: Cadmium tested

Recommended decoration: Padprint



10406000

DUNLOP

15-PIECE TOOL SET

ABS and Stainless steel.

Hammer, pliers, ratchet handle, bits and spanner with storage case. Packed in a Dunlop gift box. Exclusive Design.
18 x 30,5 x 5 cm

Compliance: Cadmium tested

Recommended decoration: Padprint



10413300



40-PIECE MINI TOOL BOX

ABS and Stainless steel.

Compact 40 piece tool box. Packed in a Dunlop Gift box. Exclusive Design.
25 x 12,8 x 9,8 cm

*Compliance: Cadmium tested
Recommended decoration: Padprint*



10407200



ULTRASONIC DIGITAL MEASURER

ABS.

A high end compact, hand held, ultrasonic measuring device. Ideal for estate agents, decorators and DIY. Including 2 pencils and a belt pouch. Packed in a Dunlop gift box. Exclusive Design.
15 x 7,5 x 4,5 cm

*Compliance: EMC • WEEE • RoHS
Recommended decoration: Padprint*



10407500



75-PIECE SCREWDRIVER SET

ABS and Stainless steel.

Professional set includes screwdriver, 1-piece adaptor, 1-piece square adaptor, ratchet handle, 11 sockets, 3 sets of bits, 34-piece of 25mm bits. This complete set comes in a Dunlop designed case with metal locks. Packed in a Dunlop gift box. Exclusive Design.
17 x 28,5 x 7 cm

*Compliance: Cadmium tested
Recommended decoration: Screenprint*



10407300



199-PIECE TOOL SET

ABS and Stainless steel.

This professional Dunlop case with metal locks includes 4-piece high quality precision screwdrivers, 3 meter measuring tape, ratchet handle with bits, 5-piece of wrenches, universal plier, diagonal plier, hammer, 10-piece sockets and 20 bits, 8-piece Hex keys and multiple nails and screws. Packed in a Dunlop gift box. Exclusive Design.
27 x 35 x 8 cm

*Compliance: Cadmium tested
Recommended decoration: Screenprint*



AUTOMOTIVE SET

ABS, EVA, 600D polyester and Stainless steel.

Professional car repair kit consisting of an adjustable wrench, long nose plier, tape, brush, cutting knife, tyre gauge, screwdriver handle with 3 adaptors, 10 bits in bits holder, 9 sockets in a socket holder and a socket spanner. Includes a rubber soft touch EVA blow moulded case. Packed in a Dunlop gift box.

Exclusive Design.

34.5 x 30 x 9 cm

Compliance: WEEE • RoHS

Recommended decoration: Engraving

10406100



47-PIECE TOOL SET

ABS and Stainless steel.

With this toolset you can get any job done. It includes hammer, adjustable spanner, level, laser level, ratchet handle with bits, professional precision screwdrivers, plastic cutter, 12-piece sockets, 3 meter measuring tape, bits and a pair of scissors. To store all your tools this set comes with a professional Dunlop case with metal locks. Packed in a Dunlop gift box.

Exclusive Design.

27 x 36 x 6 cm

Compliance: Cadmium tested

Recommended decoration: Screenprint

10407400





BEAUTY &
WELLNESS

BY AVENUE



12609900

SEASONS

MILTON CARE SET

Cotton and wood.

This exclusive set contains a soft cotton towel (30x30cm), a wooden nail brush with pumice stone to take care of nails and skin, 80g massage soap with soft white cotton fragrance. Presented in a Seasons gift box.
18 x 10,5 x 5 cm

*Compliance: Formaldehyde • PCP • APEO • Cadmium tested
Recommended decoration: Padprint*

SEASONS

KENSINGTON BATH SET

Cotton canvas and wood.

This exclusive pouch includes a wooden massage tool, 20g puff, a candle and an organza bag with satin ribbon detail which holds a 100 gram soap bar. Fragrance of the soap bar is soft white cotton. Presented in a Seasons gift box.
ø 13 x 21 cm

*Compliance: Formaldehyde • PCP • EN 15493 • EN 15426 Candles soothing behaviour • MSDS • Cadmium tested
Recommended decoration: Transfer*



12608600



12607400

SEASONS

WINSTON BATH SET

Wood, canvas and PET plastic.

This exclusive set contains bath products with a soft white cotton fragrance. 150ml of showergel, 140 gram bath salt, 2 fizzy balls and 100 gram of soap wrapped in a natural colour cotton pouch. Presented in a wooden Seasons gift box.

20,7 x 12,6 x 7,7 cm

*Compliance: PCP • Cadmium tested
Recommended decoration: Screenprint*



Avenue's Favourites

12607500



SEASONS

HAMILTON BATH SET

PET plastic, polyester and paper.

This exclusive gift set includes 250ml of shower gel and body lotion, 175 gram bath salt packed in an organza pouch with satin ribbon detail, a candle and 2 fizzer balls. All with a soft white cotton fragrance. Presented in a Seasons gift box.

20 x 19 x 6 cm

*Compliance: PCP • EN 15493 • EN 15426 Candles soothing behaviour •
Cadmium tested
Recommended decoration: Padprint*

SEASONS

100% cotton.

Bring a touch of spa-like luxury to your every day. High quality cotton towels od 550 g / m 2 with luxury borders on both sides of the towel. Exclusive design.



12610100

12610101

SEASONS

SEASONS EASTPORT TOWEL 50 X 70CM

50 x 70 cm

Compliance: Formaldehyde • PCP • APEO
Recommended decoration: Embroidery



12610200

12610201

SEASONS

SEASONS EASTPORT TOWEL 70 X 130

70 x 130 cm

Compliance: Formaldehyde • PCP • APEO
Recommended decoration: Embroidery





New

SEASONS

EASTPORT GIFT BOX

Present your Seasons towels in this luxury gift box or create your own gift set by combining a towel with a bathrobe. The options are endless.

■

EASTPORT GIFT BOX SIZE 1

Cardboard.
41,5 x 30 x 10 cm



- 12610500
- ■ 12610600

■ ■

EASTPORT GIFT BOX SIZE 2

Cardboard.
43,5 x 34,5 x 13 cm



12608700

SEASONS

TWILLSTON 2-PIECE TOWEL GIFT SET

100% Cotton 550 g/m².
 High quality cotton towels of 550 g/m² with luxury borders on both sides of the towel. Each towel has a branded locker loop. Size of a single towel is 30x50cm. This set includes 2 pieces of towels presented in a Seasons non woven gift pouch. Exclusive design.
 20 x 30 cm

*Compliance: Formaldehyde • PCP • APEO
 Recommended decoration: Embroidery*



12610000

SEASONS

CARLTON COMFORT GIFT SET

Polyester.
 This exclusive set contains a soft touch 300 g/m² microfibre towel with matching pair of slippers. Towel size is 140 x 70cm, slippers are one size fits all. Ideal gift for your guests. Presented in a Seasons gift pouch.
 22,5 x 39,5 cm

*Compliance: Formaldehyde • APEO • Cadmium tested
 Recommended decoration: Embroidery*



12608800

SEASONS

BLOOMINGTON LADIES BATHROBE

Coral fleece of 100% Polyester 245 g/m².
 Super soft ladies bathrobe with satin tape details on sleeves and pockets. Shawl collar, locker loop and self fabric belt. Presented in a Seasons gift pouch. Exclusive design.
 125 cm

*Compliance: Formaldehyde • APEO
 Recommended decoration: Embroidery*



12608900

SEASONS

BARLETT MEN'S BATHROBE

Coral fleece of 100% Polyester 245 g/m².
 Super soft men's bathrobe with cotton tape details on both pockets. Shawl collar, locker loop and self fabric belt. Presented in a Seasons gift pouch. Exclusive design.
 128 cm

*Compliance: AZO • Formaldehyde • Noncarcinogenic dyestuff • APEO • Non-allergenic dyestuff
 Recommended decoration: Embroidery*

HOME & LIVING

BY AVENUE



New

11254500



Avenue

FLOW AERATOR

Acrylic.

Exclusive design aerator. Place the aerator onto the bottle and let the wine aerate when pouring it into the glass. Enjoy the enhanced flavor, a fuller bouquet and smoother finish of your wine. Presented in an Avenue gift box. ø 3 x 10 cm

Compliance: Safe for food contact • Cadmium tested

Recommended decoration: Padprint

11254400



New

Avenue

FLOW WAITRESS KNIFE

ABS plastic and stainless steel.

A handy and easy to grip waitress knife designed and equipped with a foil cutter that slides out of the end of the handle and a stable corkscrew with lever that easily removes bottle corks. Exclusive design. Presented in an Avenue gift box. ø 3 x 11,5 cm

Compliance: Safe for food contact • Cadmium tested

Recommended decoration: Padprint



11254100

Avenue

FLOW WINE COOLER

Stainless steel.

This double-walled wine cooler keeps your wine cold without using ice. Stainless steel cooler with two tone satin and mirror finish. Presented in an Avenue gift box. Exclusive design. ø 11,1 x 20 cm

Compliance: Cadmium tested

Recommended decoration: Engraving

New



11254300

Avenue

FLOW 2-PIECE WINE SET

Metal.

Exclusive design wine pourer and stopper set. The pourer ensures controlled pouring as well as a no-drip feature. The stopper eliminates waste by preserving the flavour of previously opened bottles of wine. Presented in an Avenue gift box.
ø 3 x 7,5 cm

*Compliance: Safe for food contact • Cadmium tested
Recommended decoration: Padprint*



11254200

Avenue

FLOW 4-PIECE WINE SET

Bamboo, acrylic and metal.

Exclusive design wine set which offers all wine essentials for opening, serving and preserving your favourite wines. Containing a waiter's knife, aerator, pourer and stopper which are displayed and stored in the bamboo base. Presented in an Avenue gift box.
ø 11 x 2 cm

*Compliance: Safe for food contact • Cadmium tested
Recommended decoration: Padprint*

11254700



Avenue

FLOW WATER CARAFE

Glas, polypropylene and stainless steel.

Frosted glass water carafe with drip-free lid. The stainless steel splash guard prevents spilling and keeps water infusing garnishes inside the bottle. Suitable to be stored in the refrigerator door so you will always have cold and ready-to-serve water available. Exclusive design. Presented in an Avenue gift box. 1000ml.

ø 8,3 x 30,7 cm

Compliance: Safe for food contact • Cadmium tested

Recommended decoration: Padprint



11254800



Avenue

FLOW CARAFE WITH COOLING STICK

Glas, polypropylene and stainless steel.

Glass carafe for serving chilled wines. Simply fill the cooling stick with water, freeze it and insert it into the carafe and enjoy your chilled and well-tasting white wine. The drip-free lid is equipped with a stainless steel splash guard to prevent spilling. Also great for serving ice cold water or juices. Presented in an Avenue gift box. Exclusive design. 750ml.

ø 8,3 x 30,7 cm

Compliance: Safe for food contact • Cadmium tested

Recommended decoration: Padprint

11254000



Avenue

FLOW WINE DECANTER SET

Glas and stainless steel.

The funnel gently disperses the wine down along the glass of the decanter providing aeration and oxygenation. Let your wine sit and breathe in the wide based carafe to allow the bouquet to develop and achieve its full potential. Decanter is designed to hold 750ml of wine. Presented in an Avenue gift box. Exclusive design.

ø 22 x 16,5 cm

Compliance: Safe for food contact • Cadmium tested

Recommended decoration: Padprint



19544299

Avenue

MILO WAITRESS KNIFE

Stainless steel, wood and tin.

Waitress knife with wooden details. Presented in a gift box. Exclusive design. 17,3 x 6 x 1,7 cm

*Compliance: Safe for food contact • Cadmium tested
Recommended decoration: Engraving*



11280600

Avenue

BELGIO 2-PIECE WINE OPENER AND POURER ENSEMBLE

Wood & stainless steel.

Two piece set includes waitress corkscrew and a bottle pourer/stopper combination presented in a wooden gift box with logo plate. Exclusive design. 11,5 x 13,5 x 3,5 cm

*Compliance: Safe for food contact • Cadmium tested
Recommended decoration: Engraving*



11201400

Avenue

VALDI 3-PIECE WINE SET

Metal.

Gifset with a drip stopper, waitress knife and bottle stopper with wooden detail. Presented in a gift box. Exclusive design. 13 x 13,5 x 3,4 cm

*Compliance: Formaldehyde • PCP • Safe for food contact • Cadmium tested
Recommended decoration: Screenprint*



11225300

Avenue

BELGIO 4-PIECE WINE SET

Wood and metal.

Wine gift set with waitress knife, bottle stopper, drip stopper and wine pourer. Presented in a gift box. Including logo plate. Exclusive design. 15,5 x 15,5 x 3,2 cm

*Compliance: Safe for food contact • Cadmium tested
Recommended decoration: Padprint*



19538569

Avenue

EXECUTIVE 2-PIECE WINE BOX

Wood and metal.

Wine box with bottle stopper and waitress knife. Presented in a gift box and including logo plate. Wine bottle not included. Exclusive design.
36,5 x 11,3 x 12 cm

*Compliance: Safe for food contact • Cadmium tested
Recommended decoration: Engraving*



11237200

Avenue

BELGIO 5-PIECE WINE SET

Wood and metal.

Gift set with waitress knife, thermometer, drip stopper, bottle stopper and a bottle coaster. Presented in a gift box. Including logo plate. Exclusive design.
25,8 x 18,4 x 3,1 cm

*Compliance: Safe for food contact • Cadmium tested
Recommended decoration: Padprint*



11201600

Avenue

EXECUTIVE 9-PIECE WINE SET

Wood and metal.

Luxury wooden gift box with 2 wine stoppers, drip stopper, thermometer, foil cutter, funnel, lever corkscrew and 2 spare corkscrews. Logo plate included. Presented in a gift box.
25 x 28 x 6,5 cm

*Compliance: Safe for food contact • Cadmium tested
Recommended decoration: Padprint*



11208000

Avenue

COPANO SINGLE LEVER CORKSCREW

Metal.

Lever corkscrew presented in a gift box.
16 x 21 x 6,3 cm

*Compliance: Safe for food contact • Cadmium tested
Recommended decoration: Engraving*



11243500

Avenue

GRAPE LEVER CORKSCREW

Metal.
Modern style corkscrew with spare corkscrew. Including logo plate and presented in a gift box.
14 x 4 x 15 cm

*Compliance: Safe for food contact • Cadmium tested
Recommended decoration: Engraving*



11213600

Avenue

VENETO AUTOMATIC WINE OPENER WITH CHARGING STATION

Metal.
Automatic wine opener with recharging station, adapter and a seal cutter. Presented in a gift box.
ø 5 x 27,5 cm

*Compliance: EMC • Safe for food contact • WEEE • LVD • RoHS
Recommended decoration: Padprint*



11250800

Avenue

DURAS 8 BOTTLE WINE FRIDGE

Metal.
Stores maximum of 8 bottles of wine. The temperature switch inside allows you to set the correct temperature for red, white or rose wine. Operates on 220 - 240V. Decoration of the wine fridge is not available.
27 x 52,5 x 45 cm

Compliance: EMC • WEEE • LVD • RoHS



11207900

Avenue

BARON 12 BOTTLE WINE FRIDGE

Metal.
Wine fridge for storage of up to 12 bottles of wine. Temperature control switch located on the backside of the wine fridge. (230v 2 pin plug). PVC free. Decoration of the wine fridge is not available.
53 x 46 x 36,5 cm

Compliance: EMC • WEEE • LVD • RoHS

Avenue

MOODZ 3-PIECE COCKTAIL SET

Glass and plastic.

This set contains 2 glasses and a double walled shaker. Volume of the shaker is 340ml, volume of a single glass 116ml. Presented in gift box. Exclusive design.

30,5 x 25,5 x 12 cm

Compliance: Safe for food contact • Cadmium tested

Recommended decoration: Padprint



11235900



11235300

Avenue

CULI 13-PIECE AMUSE BOUCHE SET

Slate, ceramic, glass and metal.

Amuse bouche set consists of 3 glasses with metal spoons, 3 ceramic spoons and 3 ceramic bowls presented on a slate plate. Presented in a gift box. exclusive design.

25,5 x 25,6 x 7 cm

Compliance: Safe for food contact

Recommended decoration: Engraving

11233900



Avenue

TRENTO 4-PIECE DINNER SET

Stainless steel.

Set with grater, pizza cutter, pasta measurer and tongs. All items are dishwasher safe. Presented in gift box. Exclusive design.

28,5 x 34,8 x 3,5 cm

Compliance: Safe for food contact

Recommended decoration: Engraving

11262601



Avenue

COOK PEPPERMILL

Bamboo.

Manual bamboo peppermill with ceramic grinder and top colour pop. Presented in a gift box.

5 x 5 x 22 cm

Compliance: Formaldehyde • PCP • Safe for food contact • Cadmium tested

Recommended decoration: Padprint

11262701



11262700

Avenue

COOK CUTTINGBOARD

Bamboo.

Eco friendly cuttingboard made from bamboo with coloured detail and integrated handle. Presented in a gift box.

35 x 25 x 2 cm

Compliance: Formaldehyde • PCP • Safe for food contact • Cadmium tested

Recommended decoration: Padprint



13000800

New

SEASONS

MODESTO PICNIC CARRIER

600D PC and wood.

The picnic carrier consists of 2 compartments, one to hold your food and one to hold up to 3 bottles of wine. The set includes a cutting board, two knives and forks and a wine opener, which are stored in a separate zippered compartment. The carrier is equipped with durable straps for easy carry. Exclusive design.
27 x 17 x 28 cm

*Compliance: Formaldehyde • PCP • Safe for food contact • Cadmium tested
Recommended decoration: Transfer*

New



13000700

SEASONS

NOYACK GRILLING MITT

Cotton and silicone.

The mitts long length make it perfect for cooking items on the grill. The silicone exterior protects your hand when taking hot pots or pans out of the oven. Withstands heats up to 204°C/400°F. Exclusive design.

30 x 19 x 2 cm

Compliance: AZO • Cadmium tested
Recommended decoration: Transfer

New



13000900

SEASONS

COVE 3-IN-1 FOLDABLE BBQ TOOL

Stainless steel.

Folding BBQ tool, which holds a two-prong meat fork, a serrated knife and spatula. The tools can be folded into the long handle for economical storage. Allows quick access to the utensil you need. Presented in a Seasons gift box. Exclusive design.

40 x 4 cm

Compliance: Safe for food contact • Cadmium tested
Recommended decoration: Padprint

New



13000500

SEASONS

DOX 3-PIECE BBQ SET WITH COOLER BAG

600D Polyester and stainless steel.

A must-have for the outdoor eater or drinker. Set includes 3 pieces of BBQ tools, a spatula, tongs and fork which are organized and stored inside the front compartment of the bag. The cooler compartment is built in for keeping your drinks cold. Exclusive design.

40 x 16 x 23 cm

Compliance: Safe for food contact • Cadmium tested
Recommended decoration: Transfer



11263400

SEASONS

WELLINGTON COOLER

Stainless steel.

Keep your bottles nicely chilled. Place the bottle in the cooler and cover it with ice cubes. Suitable for bottles with a diameter of approximately up to 14cm. Presented in a Seasons gift box. Exclusive design.

ø 19 x 21,3 x 20 cm

Compliance: Cadmium tested
Recommended decoration: Engraving



SEASONS

11258100

CAPE 4-PIECE CHEESE SET

Glass and wood.

Glass cheese board with two cheese knives and a cheese fork executed with wooden handles. Presented in a Seasons gift box. Exclusive design. 22 x 22 x 0,5 cm

*Compliance: Formaldehyde • PCP • Safe for food contact • Cadmium tested
Recommended decoration: Padprint*



SEASONS

11263200

CHEVIOT WATER CARAFE

Glass.

Stylish carafe for serving water at the dinner table. Content of the carafe is 700ml. Presented in a Seasons gift box. Exclusive design. ø 9,5 x 23 cm

*Compliance: Safe for food contact • Cadmium tested
Recommended decoration: Engraving*



11263600

SEASONS

WILLET 2-PIECE WINE BOX

Wood and metal.

An elegant way to present a bottle of wine. Wooden wine box with waitress knife and drip stopper. The inside bottom of the wine box features black lining. Including logo plate. Wine bottle not included. Presented in a Seasons gift box. Exclusive design. 36,5 x 11,5 x 12 cm

*Compliance: Safe for food contact • Cadmium tested
Recommended decoration: Engraving*



11263500

SEASONS

WESTWOOD WINE RACK

Wood.

A decorative and practical way to store and display your bottles. This wine rack can store up to 6 bottles and features a chain to stop the rack from opening too much. When opened the wine rack measures 30cm x 37cm and it stands at approximately 24cm. Presented in a Seasons gift box. Exclusive design. ø 8,5 x 37 x 3 x 30 cm

*Compliance: Cadmium tested
Recommended decoration: Padprint*



11246400

SEASONS

MILANO 4-PIECE ESPRESSO SET

Ceramic.

Espresso set with 80ml cups presented in a gift box. Decoration plate included. Dishwasher safe. Exclusive design.
13,9 x 13,9 x 7 cm

*Compliance: Safe for food contact
Recommended decoration: Engraving*



11251100

SEASONS

BODA 2-PIECE ESPRESSO SET

Glass.

Double walled isolating 80ml espresso glasses. The set is presented in a luxury gift box. Logo plate included.
14 x 7,3 x 7,2 cm

*Compliance: Safe for food contact
Recommended decoration: Engraving*



11251200

SEASONS

BODA 2-PIECE COFFEE SET

Glass.

Double walled isolating 200ml coffee mugs. The set is presented in a luxury gift box. Logo plate included.
17,5 x 9 x 9,2 cm

*Compliance: Safe for food contact
Recommended decoration: Engraving*



11265000

SEASONS

BODA 2-PIECE GLASS SET

Glass.

Double walled isolating 300ml glass set. Ideal for serving your favorite latte macchiato, ice tea or any hot or cold drinks. Presented in a luxury gift box. Logo plate included.
18,5 x 9,5 x 10 cm

*Compliance: Safe for food contact
Recommended decoration: Padprint*

SEASONS

PORTO 2-PIECE STORAGE JAR SET

Metal.

Store your favourite pasta, tea or sugar in these decorative jars. The set contains 2 jars with a volume capacity of 1 liter and 2,5 liters. Presented in a Seasons gift box. Exclusive design.
ø 23 x 14 cm

Compliance: Safe for food contact • Cadmium tested
Recommended decoration: Padprint



11259300

SEASONS

TREMONT TEA BOX

Wood.

High end wooden tea box with flip top lid. The bottom of the tea box is equipped with non-scratch pads. The tea box has 6 compartments to store and preserve your favourite teabag blends. Including metal logo plate. Presented in a Seasons gift box. Exclusive design.
22,5 x 18 x 7 cm

Compliance: Formaldehyde • PCP • Cadmium tested
Recommended decoration: Engraving



11263300

SEASONS

CAMDEN COOK BOOK STAND

Wood.

This wooden stand is a decorative holder for treasured family recipes or books just off the shelf. Also suitable for tablets. Presented in a Seasons gift box. Exclusive design.
21 x 16,5 x 33 cm

Compliance: Formaldehyde • PCP • Cadmium tested
Recommended decoration: Padprint



11259500

SEASONS

SOLANO LANTERN

Glass.

Cast a warm glow in your garden, living room or any room in your house. Tea light is not included. Presented in a Seasons gift box. Exclusive design.
ø 10 x 13,1 cm

Compliance: Cadmium tested
Recommended decoration: Padprint



SEASONS

LUNAR SCENTED CANDLE

Glass.

A must have for every home. Exclusive scented candles with a light fragrance of white linen or sandalwood. Burn time of the candle is approximately 30 hours. Presented in a Seasons gift box.
ø 9 x 10 cm

Compliance: EN 15493 • EN 15426 Candles soothing behaviour • Cadmium tested
Recommended decoration: Padprint



11259400



11256401

11256400



11258000

SEASONS

NEWPORT PHOTOFRAME

Metal and glass.

A timeless silver plated photoframe. Suitable for pictures size 10 x 15cm and can be used in a standing position or attached to the wall. Presented in a Seasons gift box. Exclusive design. 15,5 x 1 x 20,6 cm

*Compliance: Cadmium tested
Recommended decoration: Engraving*



11257800

SEASONS

GREENPORT PHOTOFRAME

Wood and glass.

Treasure precious moments in your favourite photoframe. The frame can be used in a standing position or attached to any wall in your house and holds a 10 x 15cm picture. Presented in a Seasons gift box. Exclusive design. 19 x 3 x 24,5 cm

*Compliance: Formaldehyde • PCP • Cadmium tested
Recommended decoration: Padprint*



11257900

SEASONS

DALEPORT PHOTOFRAME

Wood and glass.

Decorate your favourite room with this photoframe. Can be used in a standing position or attached to the wall. The frame can hold a 13 x 18cm picture and is presented in a Seasons gift box. Exclusive design. 22 x 3 x 27 cm

*Compliance: Formaldehyde • PCP • Cadmium tested
Recommended decoration: Padprint*



11257700

SEASONS

DAVENPORT MEMORY BOARD AND PHOTOFRAME

Wood.

Treasure your favorite moments and memorabilia. This exclusive photoframe is suitable to hold a 10 x 15cm picture and includes 10 pins for holding memorabilia. Presented in a Seasons gift box. Exclusive design. 42,5 x 1,5 x 26 cm

*Compliance: Formaldehyde • PCP • Cadmium tested
Recommended decoration: Padprint*



New



11280900

SEASONS

SPRINGWOOD PLAID

100% Polyester.

A luxurious soft plaid which combines 140gsm fleece with 180gsm super soft sherpa. Printing zipper included. Presented in a Seasons gift pouch. Exclusive design.

126 x 152 cm

*Compliance: AZO • Formaldehyde • Noncarcinogenic dyestuff • APEO • Non-allergenic dyestuff • Cadmium tested
Recommended decoration: Embroidery*

New



11281000

SEASONS

BAY BLANKET

Polyester fleece.

This extra soft plush blanket is perfect to cuddle up with. Presented in a Seasons gift pouch. Exclusive design.

126 x 152 cm

*Compliance: AZO • Formaldehyde • Noncarcinogenic dyestuff • APEO • Non-allergenic dyestuff • Cadmium tested
Recommended decoration: Embroidery*

10032300



SEASONS

HAMPTONS PLAID

100% Polyester.

This plaid combines 180gsm super soft velour with 200gsm sherpa which is luxurious to the touch. Presented in Seasons gift pouch. Exclusive design.

126 x 152 cm

*Compliance: AZO • Formaldehyde • Noncarcinogenic dyestuff • APEO • Non-allergenic dyestuff • Cadmium tested
Recommended decoration: Embroidery*



11244600

**Jamie
Oliver**

3 WATER GLASSES

Recycled glass.

Glass that used to be a marmalade jar is now turned into a 35cl water glass. This set of 3 water glasses is fully made out of recycled glass. The glasses can be washed in the dishwasher. Supplied in a Jamie Oliver gift box. Exclusive design.

ø 8 x 12,7 cm

*Compliance: Safe for food contact
Recommended decoration: Padprint*



11227100

**Jamie
Oliver**

WATER CARAFE WITH GLASS

Recycled glass.

Water bottle and glass recycled from 5 Marmalade jars. Made from 100% recycled glass. Dishwasher safe. Supplied in Jamie Oliver gift box. Exclusive design.

ø 9 x 9 x 28 cm

*Compliance: Safe for food contact • Cadmium tested
Recommended decoration: Padprint*





11269100

Jamie Oliver

CARAFE

Recycled glass and cork.

Environmentally responsible carafe made of 100% recycled glass with cork stopper. Content is 800ml. The carafe, with exception of the stopper, is dishwasher safe. Supplied in a Jamie Oliver gift box. Exclusive design. ø 9,2 x 27,5 cm

*Compliance: Safe for food contact
Recommended decoration: Padprint*



11256900

Jamie Oliver

2-PIECE BAR TOOL SET

Metal.

Jamie's bar tools set for opening your favourite bottle of beer or wine. Supplied in Jamie Oliver gift box. Exclusive design. 11,5 x 20,5 x 4 cm

*Compliance: Safe for food contact
Recommended decoration: Engraving*



11269300

Jamie Oliver

JUG WITH 2 GLASSES

SAN plastic.

Vintage inspired set contains a 1.8l jug and 2 pieces of tumblers. Content of a single tumbler is 400ml. The set is made of durable SAN plastic. Dishwasher safe and shatterproof. Supplied in a Jamie Oliver gift box. Exclusive design. 15,6 x 15,9 x 23 cm

*Compliance: Safe for food contact
Recommended decoration: Padprint*



11243700

Jamie Oliver

PIZZA SET

Stoneware.

Create your own authentic Italian pizza with this pizza set. The pizza stone evenly distributes heat from the oven to the pizza and retains heat to keep the pizza warm during serving. Includes a pizza cutter. Supplied in a Jamie Oliver gift box. Exclusive design.

ø 33 x 36 x 35,5 x 4 cm

*Compliance: Safe for food contact
Recommended decoration: Padprint*



11209200

Jamie Oliver

APRON

Denim.

The original Jamie Oliver apron. One size fits all with adjustable strap, funky rivets and buttons and multiple front pockets. Supplied in Jamie Oliver packaging. Exclusive design.

71 x 102 cm

*Compliance: AZO • Formaldehyde • PCP
Recommended decoration: Transfer*





11256700

Jamie Oliver

ANTIPASTI SERVING BOARD

Acacia wood.
 An iconic Jamie serving board, perfect for breads, antipasti or cheese.
 Exclusive design.
 51,5 x 20,5 cm

*Compliance: Safe for food contact • Cadmium tested
 Recommended decoration: Engraving*



11281400

Jamie Oliver

CHEESE PLATTER

Ceramic.
 A great way to serve your cheese. This cheese platter looks stunning on any table or worktop. Includes five pieces of ceramic cheese markers to ensure you will never mix up your cheeses.
 24 x 23 cm

*Compliance: Safe for food contact • Cadmium tested
 Recommended decoration: Engraving*





11255800

Jamie Oliver

3-PIECE KITCHEN TOOL SET

Stainless steel.

What is a chef without his tools? This practical and fun kitchen tool set includes a slotted turner, spoon and a slotted spoon. Supplied in a Jamie Oliver gift box. Exclusive design.
35,5 x 9 x 16,5 cm

*Compliance: Safe for food contact
Recommended decoration: Padprint*



11268900

Jamie Oliver

24-PIECE CUTLERY SET

Stainless steel.

Cutlery set with a clean and modern design. Contains forks, knives, spoons and tea spoons in 18/0 stainless steel with a polished finish. Dishwasher safe. Supplied in a Jamie Oliver gift box. Exclusive design.
25 x 26,5 x 8,5 cm

*Compliance: Safe for food contact
Recommended decoration: Engraving*



11281500

Jamie Oliver

JUMBO 8-PIECE CUTLERY SET

Acacia wood and stainless steel.

A must-have for every meat eater. The set contains 4 steak knives and 4 forks. Supplied in a Jamie Oliver gift box (15x28.5x4.5cm) Exclusive design.
1,8 x 25 cm

*Compliance: PCP • Safe for food contact • Cadmium tested
Recommended decoration: Engraving*



11253200

Jamie Oliver

4-PIECE JUMBO STEAK KNIVES

Acacia wood and stainless steel.

Tuck into your favourite cooked meats with ease using these tough steak knives. Supplied in a Jamie Oliver gift box. Exclusive design.
3 x 1,8 x 25 cm

*Compliance: Formaldehyde • PCP • Safe for food contact
Recommended decoration: Engraving*



Avenue's
Favourites



11253700

Jamie
Oliver

FUNKY KNIFE SET

Stainless steel.

Set includes 15cm chef's knife, 11cm serrated knife and 8.5cm paring knife. Durable non-stick coating, dishwasher safe. Supplied in a Jamie Oliver gift box. Exclusive design.
13,7 x 30 x 3,5 cm

*Compliance: Safe for food contact
Recommended decoration: Padprint*

11226100



Jamie
Oliver

5-PIECE KNIFE BLOCK

Stainless steel and polycarbonate.

Knife block includes 11cm paring knife, 15cm utility knife, 19cm chef's knife, 20cm carving knife and a 22cm bread knife. Body of the block has inbuilt weight for stability. Supplied in a Jamie Oliver gift box. Exclusive design.
21,5 x 7,5 x 37,5 cm

*Compliance: Safe for food contact
Recommended decoration: Doming*



11258600

MARKS MAN

ELEMENT CHEF'S KNIFE AND WHETSTONE

Stainless steel, TPR and metal.

Exclusive Marksman design 8" chef's knife crafted from stainless steel, each blade has a nonstick coating and a finely sharpened edge for superior cutting performance. Handles are made from TPR with a brushed metal cap. The whetstone is used for sharpening knives. Presented in a Marksman gift box. 36,5 x 14,5 x 3,5 cm

*Compliance: Safe for food contact • Cadmium tested
Recommended decoration: Engraving*



11258700

MARKS MAN

ELEMENT 3-PIECE KNIFE SET

Stainless steel, TPR and metal.

Exclusive Marksman design knife set. This set includes the essential kitchen knives: an 8" chef's knife, a 5" serrated knife and a 3.5" paring knife. All knives are crafted from stainless steel, each blade has a nonstick coating and a finely sharpened edge for superior cutting performance. Handles are made from TPR with a brushed metal cap. Presented in a Marksman gift box. 36,5 x 16,5 x 3 cm

*Compliance: Safe for food contact • Cadmium tested
Recommended decoration: Engraving*



11258800

MARKS MAN

ELEMENT CUTTING BOARD AND CHEF'S KNIFE

Bamboo, stainless steel, TPR and metal.

A basic set for preparing food in your kitchen. A durable bamboo cutting board and an 8" chef's knife crafted from stainless steel with a nonstick coating and a finely sharpened edge for superior cutting performance. Presented in a Marksman gift box. Exclusive design. 40 x 37 x 4 cm

*Compliance: Formaldehyde • PCP • Safe for food contact • Cadmium tested
Recommended decoration: Engraving*



11269000

MARKS MAN

ELEMENT 4-PIECE KNIFE SET AND WHETSTONE

Stainless steel, TPR and metal.

This set includes a full range of most-used kitchen knives. It offers an 8" chef's knife, an 8" bread knife, a 5" serrated knife and a 3.5" paring knife. Crafted from stainless steel, each blade has a nonstick coating and a finely sharpened edge for superior cutting performance. The handles are made from TPR material with a brushed metal cap. The whetstone is used for sharpening the knives. Presented in a Marksman gift box. Exclusive design. 43,5 x 22 x 3,5 cm

*Compliance: Safe for food contact • Cadmium tested
Recommended decoration: Engraving*



11265200

Paul Bocuse

TINT KNIFE AND PEELER SET

Stainless steel, ABS and polypropylene.

This trio is an essential set for any kitchen. It consists of a 3.5" paring knife, a 4.5" serrated knife and a peeler. The knives are crafted from stainless steel with ABS handle, the peeler is equipped with a stainless steel double sided blade for faster and easier peeling. Presented in a Paul Bocuse gift box. Exclusive design.

24 x 11 x 2 cm

*Compliance: Safe for food contact • Cadmium tested
Recommended decoration: Engraving*



11265300

Paul Bocuse

TINT 4-PIECE STEAK KNIFE SET

Stainless steel and ABS.

This set consists of four pieces of steak knives. Crafted from stainless steel with sharp serrated edges to cut easily through your meat. The colorful handles are made from ABS. Presented in a Paul Bocuse gift box. Exclusive design.

25 x 13 x 2 cm

*Compliance: Safe for food contact • Cadmium tested
Recommended decoration: Engraving*



11248200

Paul Bocuse

ESSENTIAL CHEF'S KNIFE

Stainless steel and ABS.

An essential item for every chef. 8" Stainless steel blade with ABS handle. The knife is presented in a Paul Bocuse gift box. Exclusive design.

36,5 x 8,8 x 3,3 cm

*Compliance: Safe for food contact • Cadmium tested
Recommended decoration: Engraving*



11248300

Paul Bocuse

ESSENTIAL CARVING SET

Stainless steel and ABS.

Carving set for ease of use when carving poultry and roasts. 8" Carving knife and fork with stainless steel blade and ABS handle. Presented in a Paul Bocuse gift box. Exclusive design.

36,5 x 12,8 x 3 cm

*Compliance: Safe for food contact • Cadmium tested
Recommended decoration: Engraving*

11248400



Paul Bocuse

ESSENTIAL 5-PIECE KNIFE BLOCK

Stainless steel, ABS and wood.

This classic style knife block offers 5 essential kitchen tools including a 8" chef's knife, 8" bread knife, 5" paring knife, 4" paring knife and a 8" sharpening steel. All knife blades and the sharpening steel are made of stainless steel with an ABS handle. Presented in a Paul Bocuse gift box. Exclusive design.
15,5 x 13,6 x 36 cm

*Compliance: Formaldehyde • PCP • Safe for food contact • Cadmium tested
Recommended decoration: Engraving*



11239500

Paul Bocuse

FINESSE CHEF'S KNIFE

Stainless steel and ABS.

The chef's knife from the Finesse line is made of high quality X50CrMoV15 stainless steel and ABS handle. The knife is presented in a luxury Paul Bocuse gift box. Exclusive design.
40 x 10 x 4 cm

*Compliance: Safe for food contact • Cadmium tested
Recommended decoration: Engraving*



11245200

Paul Bocuse

FINESSE CARVING SET

Stainless steel and ABS.

This carving set from the Finesse line is the perfect gift for every chef. The carving knife and fork are made of high quality X50CrMoV15 stainless steel with ABS handle. The set is packed in a luxury Paul Bocuse gift box. Exclusive design.
37 x 12 x 4 cm

*Compliance: Safe for food contact • Cadmium tested
Recommended decoration: Engraving*



Paul Bocuse

11258200

CARRO SERVING BOARD

Bamboo and metal.

Present your favourite cheese or small dishes on this elegant serving board. Presented in a Paul Bocuse gift box. Exclusive design.
 ø 27 x 2,5 cm

*Compliance: Formaldehyde • PCP • Safe for food contact • Cadmium tested
 Recommended decoration: Engraving*



11256500

Paul Bocuse

BISTRO CUTTING BOARD WITH BREAD KNIFE

Bamboo, stainless steel and ABS.

Cutting board with integrated bread knife is ideal for cutting bread. The horizontal open pattern allows crumbs to fall through to the tray below, keeping your workspace or dinertable crumb-free. Presented in a Paul Bocuse gift box. Exclusive design.
 38 x 25 x 3,5 cm

*Compliance: Formaldehyde • PCP • Safe for food contact • Cadmium tested
 Recommended decoration: Engraving*



11239600

Paul Bocuse

GOURMET CUTTING BOARD

Bamboo.

Solid cutting board with juice groove to retain liquids and integrated handles. Presented in a Paul Bocuse gift box. Exclusive design.
 48 x 28 x 2,9 cm

*Compliance: Formaldehyde • PCP • Safe for food contact
 Recommended decoration: Engraving*



11251300

Paul Bocuse

CUISINE CUTTING AND SERVING SET

Porcelain, bamboo and polypropylene.

Elegant set for preparing and serving dinner courses. This set contains 3 colour indicated polypropylene cutting boards for hygienic food preparation, a bamboo cutting board and a porcelain serving tray. Presented in a Paul Bocuse gift box. PVC free. Exclusive design.
 28,4 x 25,6 x 4,6 cm

*Compliance: Formaldehyde • PCP • Safe for food contact • Cadmium tested
 Recommended decoration: Engraving*

11250600



Paul Bocuse

CLASSICO PEPPER MILL

Wood.

Classic manual pepper mill with ceramic grinder. Peppercorn is not included. Presented in a Paul Bocuse gift box. Exclusive design.
ø 7 x 25,5 cm

*Compliance: Formaldehyde • PCP • Safe for food contact • Cadmium tested
Recommended decoration: Engraving*

*Avenue's
Favourites*



11206900



11211500

Paul Bocuse

DUAL PEPPER AND SALT GRINDER

Stainless steel.

2 sided grinder with one end for salt and the other for pepper. Peppercorn and salt are not included. Presented in a Paul Bocuse gift box. Exclusive design.
ø 5 x 22 cm

*Compliance: Safe for food contact • Phthalates • Cadmium tested
Recommended decoration: Engraving*

Paul Bocuse

SOLO ELECTRIC PEPPER MILL

Stainless steel.

Automatic pepper mill with ceramic grinder. Peppercorn and batteries are not included. Pepper mill operates on 6 pieces of AAA batteries. Presented in a Paul Bocuse gift box. Exclusive design.
ø 5 x 22 cm

*Compliance: EMC • Safe for food contact • Phthalates • WEEE • RoHS
Recommended decoration: Engraving*



11265400

Paul Bocuse

NORON WINE COOLER SLEEVE

600D Polyester and PVC.

Easy way to serve chilled wines. Place the inner gel coat into the freezer, when ready place it back into the sleeve and put your bottle of wine inside. As the sleeve is foldable it is easy to take with you on a picnic and easy for storing. Presented in a Paul Bocuse gift box. Exclusive design.
 ø 10 x 23 cm

Compliance: Cadmium tested
 Recommended decoration: Screenprint

11280300



New

Paul Bocuse

VINE WINE TOTE

600D Polyester & Vinyl.

This wine tote is perfect for wine on the go. This insulated tote can hold one bottle of wine or champagne and features a side and deep front pocket to provide additional storage. Exclusive design. Presented in a Paul Bocuse gift box.
 12 x 9 x 40 cm

Compliance: Cadmium tested
 Recommended decoration: Debossing



11250000

Paul Bocuse

COULAN WINE COOLER

Stainless steel.

Double walled stainless steel wine cooler presented in a Paul Bocuse gift box. Exclusive design.
 ø 12 x 19 cm

Compliance: Cadmium tested
 Recommended decoration: Engraving



New

Paul Bocuse

MINO 5-PIECE WINE SET

Wood, stainless steel and vinyl.

Set includes a stainless steel waitress corkscrew and four square coasters with fine detailed stitching around the edges and velvet flocked bottom. Presented in a wooden gift box including logo plate and Paul Bocuse gift box. Exclusive design.

14,5 x 15 x 3,1 cm

Compliance: Safe for food contact • Cadmium tested

Recommended decoration: Debossing



11280100

Paul Bocuse

VINE 3-PIECE WINE SET

Wood.

This wine set includes a corkscrew, foil cutter and wine pourer. The wine set is presented in a wooden gift box with metal logo plate and packed in a Paul Bocuse gift box. Exclusive design.

16,5 x 14,5 x 4,5 cm

Compliance: Safe for food contact • Cadmium tested

Recommended decoration: Engraving



11257600

Paul Bocuse

VINE WINE AERATOR

Acrylic.

Wine needs to breathe. The aerator from the Paul Bocuse collection aerates the wine when pouring it into your glass. It creates a better bouquet and enhances the flavor. Displayed in a wooden box with metal logo plate and presented in a Paul Bocuse gift box. Exclusive design.

18,3 x 10,5 x 7,5 cm

Compliance: Safe for food contact • Cadmium tested

Recommended decoration: Engraving



11259200



11265500



Paul Bocuse

MINO WINE AND CHEESE ENSEMBLE

Wood and stainless steel.

This six piece set includes a solid wood cutting board, three cheese knives for cutting soft, hard and aged cheeses, a wine bottle stopper and waitress corkscrew. The set is presented in a wooden gift box with metal logo plate. Packed in a Paul Bocuse gift box. Exclusive design. 24 x 24 x 5,5 cm

*Compliance: Formaldehyde • PCP • Safe for food contact • Cadmium tested
Recommended decoration: Engraving*

Paul Bocuse

PRESTIGE DECANTER WITH 2 WINE GLASSES

Glass.

Elegant carafe for serving red and white wines. The set consists of a glass carafe and 2 matching wine glasses. Volume of the carafe is 1.1l, volume of a wine glass is 450ml. Presented in a Paul Bocuse protective drop box. Exclusive design.
24 x 19 x 35 cm

Compliance: Safe for food contact
Recommended decoration: Engraving



11259000



11259100

Paul Bocuse

PRESTIGE CARAFE WITH 4 GLASSES

Glass.

Serve in style with this glass carafe and 4 piece matching glasses. Volume of the carafe is 1000ml and volume of a glass is 370ml. Dishwasher safe. Presented in a Paul Bocuse protective drop box. Exclusive design.
33,8 x 10,5 x 28,8 cm

Compliance: Safe for food contact
Recommended decoration: Engraving

DRINKWARE

BY AVENUE





Avenue



reddot award 2014
winner

FLOW BOTTLE

BPA free tritan copolyester and silicone.

The flow bottle is made of durable Eastman tritan material which is shatter, stain and odor resistant. BPA free. Easy carrying due to the silicone strap. Volume is 650ml. Red Dot winner 2014 and IF Award Winner 2014. Presented in a gift box. Exclusive design.
ø 7,5 x 24 cm

Compliance: Safe for food contact • Cadmium tested
Recommended decoration: Screenround



Avenue



reddot award 2014
winner

FLOW NON LEAKING ISOLATING TUMBLER

Stainless steel exterior, plastic interior.

The flow tumbler is a double wall foam insulated tumbler. It is equipped with a single-hand, screw-on push button lid with a non leaking function to make sure your drink stays put. The silicone pad on the bottom makes the tumbler skid-proof. Volume is 350ml. Red Dot winner 2014 and IF Award Winner 2014. Presented in a gift box. Exclusive design.
ø 7,2 x 18,5 cm

Compliance: Safe for food contact • Cadmium tested
Recommended decoration: Screenround



Avenue

FLOW VACUUM ISOLATING FLASK

Stainless steel interior and exterior.

The flow flask is a double wall stainless steel flask with vacuum isolation. This isolation provides the longest temperature retention. Equipped with a single-hand, push button pour spout and an integrated mug in cap. Top of the mug and bottom have skid-proof silicone pads. Volume is 500ml. Presented in a gift box. Exclusive design.
ø 7,5 x 26 cm

Compliance: Safe for food contact • Cadmium tested
Recommended decoration: Screenround



Avenue

FOX BOTTLE

BPA free tritan and aluminium.

Modern design bottle with twist-on spill resistant lid. Volume is 900ml.

Presented in a gift box.

ø 7,5 x 27 cm

Compliance: Safe for food contact • Cadmium tested

Recommended decoration: Screenround



10023601

10023602

10023600



10029001

10029002

10029003

10029000

Avenue

BRIGHTON BOTTLE

BPA free tritan and silicone.

Single wall bottle with removable silicone ring for easy cleaning . Twist-on lid. Volume is 470ml. Presented in a gift box.

ø 6,6 x 22,8 cm

Compliance: Safe for food contact • Cadmium tested

Recommended decoration: Padprint



10029101

10029100

Avenue

WAVE ISOLATING TUMBLER

BPA free polypropylene.

Sporty double wall tumbler with ergonomic design for easy comfortable grip.

Push-on thumb slide lid. Volume is 500ml. Presented in a gift box.

ø 9,1 x 19,5 cm

Compliance: Safe for food contact • Cadmium tested

Recommended decoration: Screenround

Avenue

CURVE ISOLATING NON LEAKING TUMBLER

BPA free acrylic.

Double wall drinking bottle with twist-on lid and 360 degree drinkability.
Volume is 400ml. Presented in a gift box.
ø 8,3 x 22 cm

Compliance: Safe for food contact • Cadmium tested
Recommended decoration: Screenround



10023800

10023801



10033400

10033401

10033402

Avenue

SIPPER ISOLATING BOTTLE

Acrylic.

Some like it hot and some like it cold. With this 2-in-1 lid you can have both. Double wall bottle with screw-on lid with a pull up stopper for drinking hot beverages and an integrated pull up straw for cold beverages. Volume is 570ml. Presented in a gift box. Exclusive lid design.
ø 8,5 x 22 cm

Compliance: Safe for food contact • Cadmium tested
Recommended decoration: Screenround

Avenue

TECH ISOLATING MUG

Stainless steel interior and exterior.

Double wall isolating stainless steel mug with push on thumb-slide lid.
Volume of 330ml. Presented in a gift box.
ø 8 x 18 cm

Compliance: Safe for food contact • Cadmium tested
Recommended decoration: Padprint



10014500

New



10039300

Avenue

ZISSOU TUMBLER

Stainless steel.

This double wall stainless colorful tumbler will delight you. Easy drink through thumb-slide push-on lid. The thumb slide color matches the body. Volume is 500 ml. Presented in a gift box.
ø 6,3 x 20,3 cm

Compliance: Safe for food contact • Cadmium tested
Recommended decoration: Padprint

10029300



10029302



10029301

Avenue

STELT ISOLATING VACUUM NON LEAKING TUMBLER

Stainless steel interior and exterior.

Double wall stainless steel tumbler with vacuum isolation. This type of isolation provides the longest temperature retention. The tumbler has a non leaking screw-on lid with an integrated push button pour spout. Volume is 400ml. Presented in a gift box.
ø 7,3 x 21 cm

Compliance: Safe for food contact • Cadmium tested
Recommended decoration: Screenround



Avenue

EVEREST ISOLATING FLASK WITH STRAP

Stainless steel interior and exterior.

Double wall stainless steel isolating flask with handle and nylon strap which can be attached to the flask for easy travelling. The large capacity of 1L makes this flask ideal for outdoor activities. The cap can be used as a mug. Presented in a gift box.
ø 11 x 27,5 cm

Compliance: Safe for food contact • Cadmium tested
Recommended decoration: Padprint

19543103



10017500



Avenue

HOT AND COOL SET

Aluminium, stainless steel interior and exterior.

Double wall isolating stainless steel red 500ml flask. Single-hand, push-button pour spout which closes automatically when screwing the cup lid on to the bottle. Single wall aluminium blue 750ml bottle. Presented together in a gift box. Exclusive design.
22 x 33 x 7,5 cm

*Compliance: Safe for food contact • Cadmium tested
Recommended decoration: Padprint*

New



10039400

Avenue

VERTEX GEOMETRIC BOTTLE

Stainless steel with plastic casing.

Stainless steel inner wall with geometric cuts, outer wall in smooth acrylic material for logo adhesion. Lid is screw on/off. Stainless steel inner wall is removable for easy cleaning or use of the acrylic bottle without the liner. Volume is 475 ml. Presented in a gift box.
ø 7,6 x 22,9 cm

*Compliance: Safe for food contact • Cadmium tested
Recommended decoration: Screenround*

New



10039500



10039501



elleven

TRAVERSE TUMBLER

Stainless steel.

Double wall vacuum insulated stainless steel tumbler with flip top lid and an intricate geometric cut design. Volume is 475 ml. Presented in an Elleven gift box.
ø 6,7 x 23,5 cm

*Compliance: Safe for food contact • Cadmium tested
Recommended decoration: Screenround*





New



10040100

Avenue



10040101



10040102

RADIUS GEOMETRIC SPORT BOTTLE

BPA-free Eastman Tritan™ Material.

Geometric style single wall bottle with smooth grip area for logo application. Twist-on lid features handle and flip up straw. Volume capacity is 830 ml. Presented in a gift box. ø 7,8 x 27 cm

*Compliance: Safe for food contact • Cadmium tested
Recommended decoration: Padprint*

New



10042000

Zoom

RHYTHM BLUETOOTH™ AUDIO FLASK

PP plastic.

This audio flask rocks out with an 530 ml. capacity to keep you hydrated. It boasts a removable, light-up, Bluetooth™ speaker that blasts your favorite soundtrack to keep you motivated and supports conference calls for easy, hands-free operation. The speaker is complete with flashing LED lights that compliment music and video play while a built in media stand works with most large smart phones to provide hours of on the go entertainment. Bluetooth™ working range is 10 meters. Includes Micro-USB to USB charging cable. Presented in gift box. Exclusive design. ø 7,8 x 25 cm

*Compliance: EMC • Safe for food contact • WEEE • Battery Directive • RoHS
• Cadmium tested
Recommended decoration: Screenround*





New



Avenue

MOSCOW MULE MUG GIFT SET

Copper coated aluminium.

Gift set inspired by the popular Moscow Mule cocktail. Aluminum construction with full copper coating. Gift box features a robust history of the cocktail and a recipe card is included. Each mug is 415 ml. 9 x 18,9 x 11 cm

Compliance: Safe for food contact • Cadmium tested
Recommended decoration: Engraving



10034800

ELEVATE

RAMBLER NON LEAKING BOTTLE

Stainless steel and BPA free tritan copolyester.

The Rambler bottle is a single wall stainless steel bottle with non-leaking function. Screw-on dual purpose lid with small and large openings for easy use and cleaning. Equipped with a carabineer to hook the bottle onto your bag and metal D-ring for easy carrying. Volume of the bottle is 700ml. Presented in a gift box. Exclusive design. BPA free.
ø 7,7 x 21,8 cm

*Compliance: Safe for food contact • Cadmium tested
Recommended decoration: Padprint*



10034900

ELEVATE

WARDEN NON LEAKING HIP FLASK

Aluminium, polypropylene and metal.

The Warden hip flask is a single wall aluminum bottle with non-leaking function. Screw-on cap is equipped with a metal D-ring for easy carrying and attachment to your carabineer. Volume of the bottle is 500ml. Presented in a gift box. Exclusive design. BPA free.
5 x 9,5 x 16,8 cm

*Compliance: Safe for food contact • Cadmium tested
Recommended decoration: Padprint*



10034700

*Avenue's
Favourites*

ELEVATE

NAKISKA VACUUM ISOLATING FLASK

Stainless steel interior and exterior.

The Nakiska flask is a double wall stainless steel flask with vacuum isolation. This type of isolation provides the longest temperature retention. Equipped with a push button pour spout and an integrated drinking cup in cap. Volume of the flask is 600ml, volume of the cup is 200ml. Presented in a gift box. Exclusive design.
ø 8 x 24,5 cm

*Compliance: Safe for food contact • Cadmium tested
Recommended decoration: Padprint*



A woman with dark hair and eyes is holding a blue notebook in front of her face. The notebook has a textured cover and a dark blue elastic strap. The background is a dark, patterned fabric. A vertical yellow bar is on the right side of the image.

NOTEBOOKS
& PORTFOLIOS
BY AVENUE

JOURNALBOOKS

CLASSIC NOTEBOOK

This exclusive design classic hard cover notebook with elastic closure and 80 sheets (80gsm) of lined paper is ideal for writing and sharing notes. Features an expandable pocket at the back to keep small notes. Incl. Journalbooks gift box sleeve.

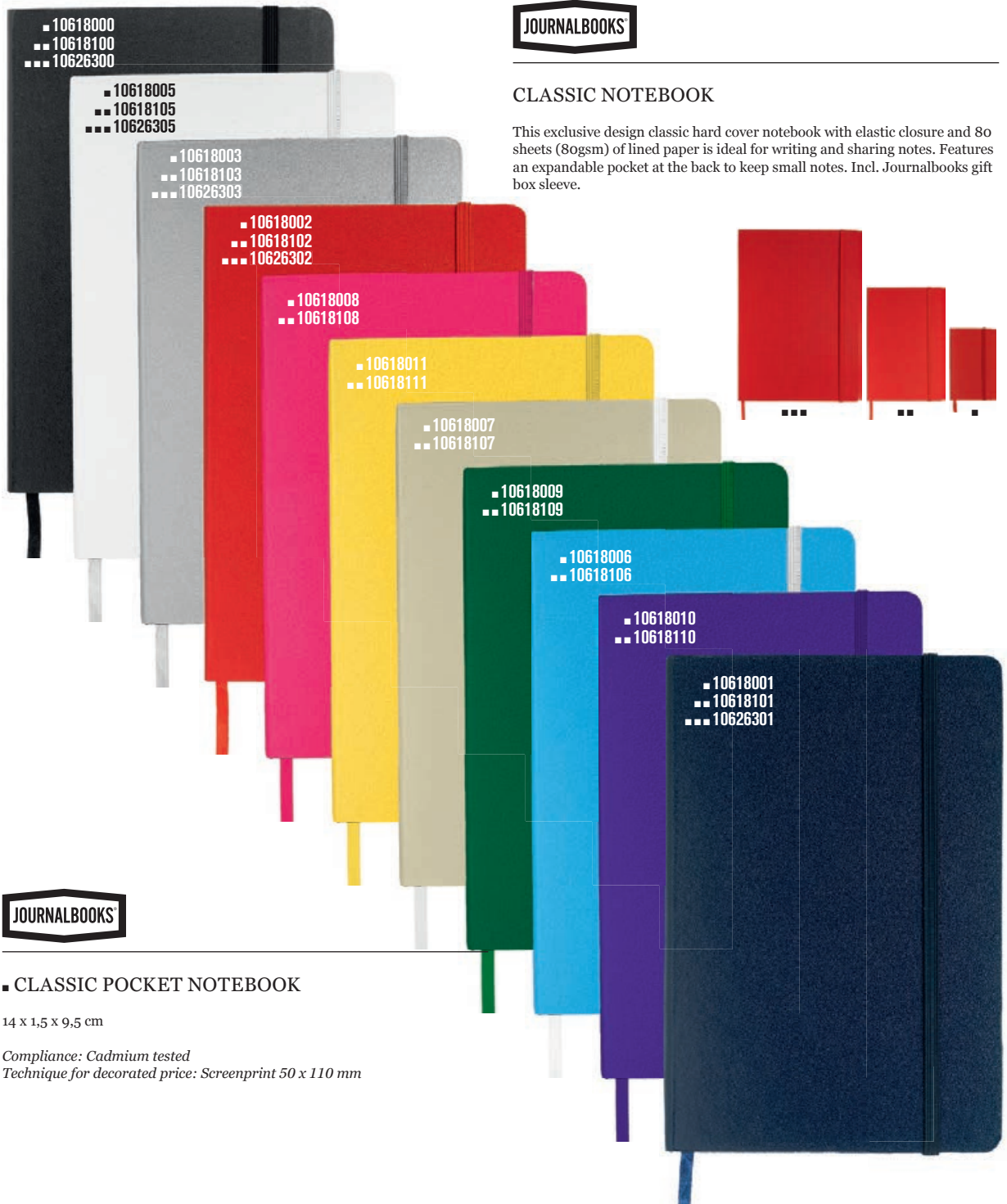

JOURNALBOOKS

■ CLASSIC POCKET NOTEBOOK

14 x 1,5 x 9,5 cm

Compliance: Cadmium tested

Technique for decorated price: Screenprint 50 x 110 mm

JOURNALBOOKS

■■ CLASSIC OFFICE NOTEBOOK

21,3 x 14,5 x 1,2 cm

Compliance: Cadmium tested

Technique for decorated price: Screenprint 90 x 180 mm

JOURNALBOOKS

■■■ CLASSIC EXECUTIVE NOTEBOOK

20,9 x 1,2 x 29,8 cm

Compliance: Cadmium tested

Technique for decorated price: Screenprint 150 x 200 mm

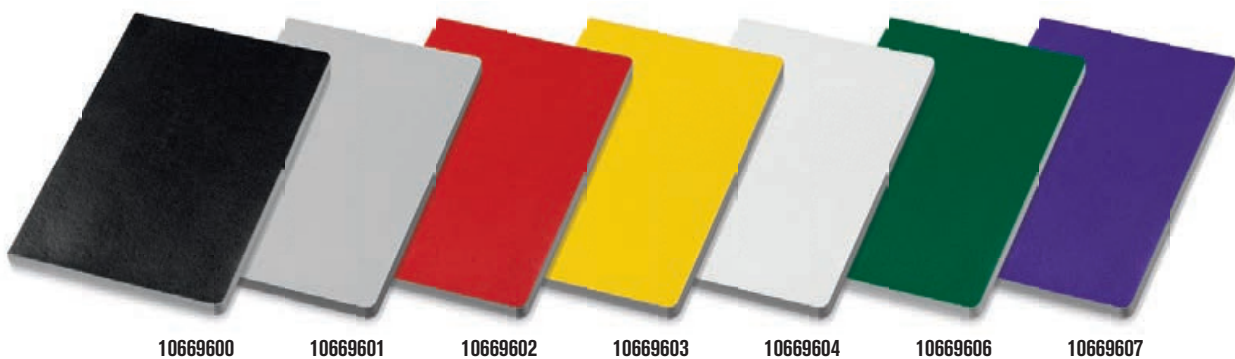

10669600

10669601

10669602

10669603

10669604

10669606

10669607



CITY NOTEBOOK

Leatherette paper.

Soft and flexible in a choice of colours (A5 size reference) exclusive design notebook, just the job for jotting down notes on-the-go. Features 80 sheets (80gsm) lined paper. Packed in a Journalbooks gift box sleeve. 21 x 14 x 1 cm

Compliance: Cadmium tested

Technique for decorated price: Screenprint 100 x 170 mm



10680802

10680801

10680800



FLEX BACK COVER OFFICE NOTEBOOK

Cardboard.

Notebook with back cover crease for easy page turning. Includes elastic closure, ribbon page marker and 80 sheets (80gsm) of lined paper. Patent pending. 21,3 x 14,2 cm

Compliance: Cadmium tested

Technique for decorated price: Screenprint 90 x 180 mm

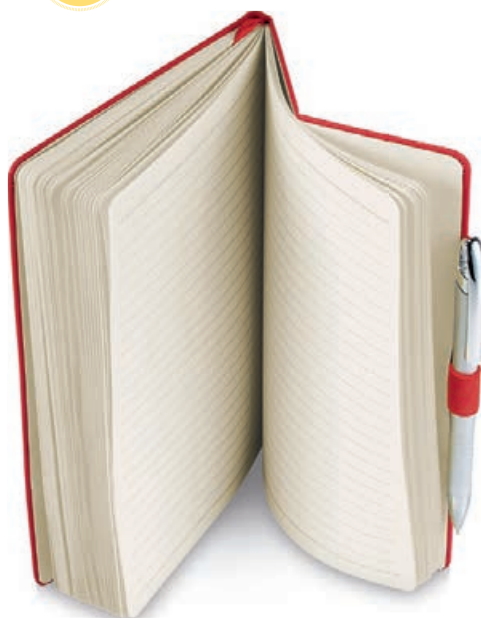

New

JOURNALBOOKS

CLASSIC SOFT COVER NOTEBOOK

Thermo PU.

Soft touch cover notebook with built in elastic closure, ribbon page marker, document pocket on interior back cover and 80 sheets (80gsm) of lined paper.
21 x 14 cm

Compliance: Cadmium tested

Technique for decorated price: Screenprint 80 x 160 mm



10683000

10683002

10683001

■ 10676400

■ 10676300

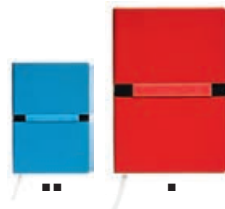

■ 10676402

■ 10676302

■ 10676401

■ 10676301

JOURNALBOOKS

■ STRETTO NOTEBOOK A5

Thermo PU.

This smartly designed notebook (A5 reference) offer a distinctively different decoration opportunity thanks to a sturdy, spine-connected elastic band with a dedicated decoration area. Features 96 lined sheets (80gsm), packed in a Journalbooks gift sleeve.
21,3 x 14,3 cm

Compliance: Cadmium tested

Technique for decorated price: Screenprint 110 x 65 mm

JOURNALBOOKS

■ STRETTO NOTEBOOK A6

Thermo PU.

This smartly designed notebook (A6 reference) offer a distinctively different decoration opportunity thanks to a sturdy, spine-connected elastic band with a dedicated decoration area. Features 96 lined sheets (80gsm), packed in a Journalbooks gift sleeve.
15,1 x 10,8 cm

Compliance: Cadmium tested

Technique for decorated price: Screenprint 75 x 30 mm

CUPPIA NOTEBOOK

Cardboard.

A coloured spine and elastic closure add a touch of character to this classic exclusive design black hardcover notebook (A5 size reference), while helping distinguish it from others. Practical convenience comes from an elasticated pen loop on the spine. Features 80 sheets (80 gsm) of lined paper. Packed in a Journalbooks gift box sleeve. 20,4 x 14,1 x 1,1 cm

Compliance: Cadmium tested

Technique for decorated price: Screenprint 80 x 165 mm



10669200

10669202

10669201



DOPPIO NOTEBOOK

Imitation leather.

This exclusive design 2-in-1 notebook (A5 size reference) is a neat solution for keeping two different projects on-the-go. Two different coloured covers identify the separate parts of the notebook. Simply flip it over to switch your line of thinking. Features 2x 64 lined pages (80gsm), packed in a Journalbooks gift sleeve. 21,3 x 14,5 x 2 cm

Compliance: Cadmium tested

Technique for decorated price: Screenprint 100 x 170 mm



10669000



10669001



10669002



10669100

MARKS AN

ECHO REPORTER NOTEBOOK

Cardboard covered with leather paper.

Exclusive design handy little notebook for taking notes, without taking up too much space in your bag or pocket. Features 40 sheets (100gsm) lined and 40 sheets (100gsm) blank paper with perforated edges. Packed in a Marksman gift box.

14,2 x 8,8 cm

Compliance: Cadmium tested

Technique for decorated price: Screenprint 50 x 45 mm



10681100

MARKS AN

ALPHA NOTEBOOK II

Cardboard.

Exclusive design notebook (80 sheets/80 gsm lined white paper) incl. black ribbon marker, a blue page divider with black elastic band closure and small pocket inside of the back cover. The page divider can be used to hold small notes and the small pocket inside to hold business cards. The notebook comes including an extra booklet (16 sheets/ 80 gsm blank white paper) for making separate notes or calculations. Incl. Marksman gift box.

18,6 x 13,1 cm

Compliance: Cadmium tested

Technique for decorated price: Screenprint 80 x 110 mm



10681000



MARKS AN

COSMOS NOTEBOOK

Cardboard.

Exclusive design notebook (80 sheets, 80 gsm white lined paper) including black imitation leather pouch which fits snugly around the front cover of the notebook. The clever tool pouch offers several options to carry along your daily essentials such as pens, smartphone, business cards and glasses. Incl. Marksman gift box.

21,3 x 14,3 cm

Compliance: Cadmium tested

Technique for decorated price: Screenprint 100 x 150 mm



10646000

MARKS  AN

DELTA NOTEBOOK

Leather paper covered cardboard.

Exclusive design square notebook with 80 sheets (100gr.) lined paper, elastic closure and inner pocket at the back to store notes and businesscards. The upperpart of the inner pocket can also be used as a pen loop. Packed in a black Marksman gift box.
18 x 15 cm

Compliance: Cadmium tested

Technique for decorated price: Screenprint 130 x 85 mm

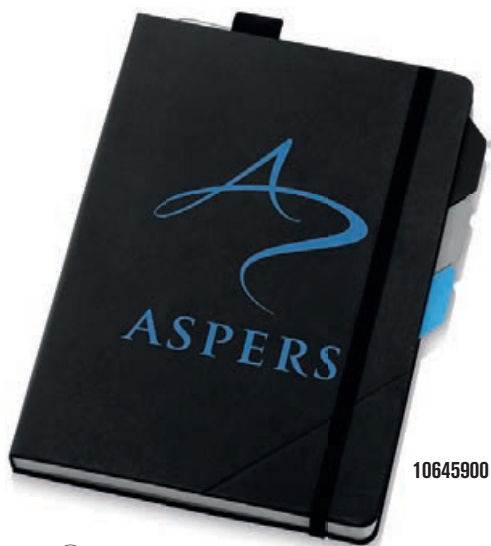

10645900

MARKS  AN

ALPHA NOTEBOOK INCL. PAGE DIVIDERS

Leather paper covered cardboard.

Exclusive design notebook with 96 sheets (100gsm) lined paper, elastic closure and 3 page dividers which can be used as marker or section identifier. The Alpha also includes an inner pocket at the back to store notes and business cards and a pen loop attached on one of the page dividers. Packed in a Marksman gift box.
21 x 14,5 cm

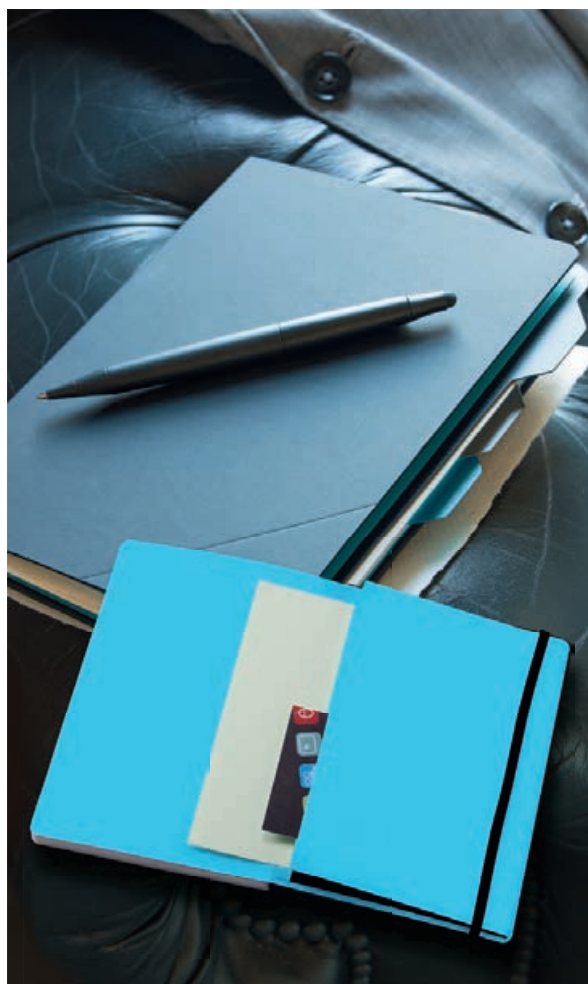

Compliance: PVC Free • Cadmium tested

Technique for decorated price: Screenprint 90 x 140 mm



10634904

BALMAIN
PARIS

NOTEBOOK MINI (A6 REF)

Cardboard covered with fabric.

This classic fabric cover notebook with elastic closure and 80 sheets (80gsm) of lined paper is ideal for writing and sharing notes. Features an expandable pocket at the back to keep small notes. Incl. gift box.
8,9 x 1,2 x 14,4 cm

Technique for decorated price: Screenprint 50 x 110 mm



10634804

BALMAIN
PARIS

NOTEBOOK MIDI (A5 REF)

Cardboard covered with fabric.

This classic fabric cover notebook with elastic closure and 80 sheets (80gsm) of lined paper is ideal for writing and sharing notes. Features an expandable pocket at the back to keep small notes. Incl. gift box.
14,7 x 1,2 x 21,3 cm

Technique for decorated price: Screenprint 90 x 180 mm



10618200

BALMAIN
PARIS

POCKET NOTEBOOK (A6 REF)

Cardboard covered with leatherette paper.

Luxury hard cover notebook with elastic closure and 96 sheets (80gsm) of lined paper, ideal for writing and sharing notes. Features an expandable pocket at the back to keep small notes. Incl. gift box.
9,5 x 1,5 x 14 cm

Compliance: Cadmium tested

Technique for decorated price: Screenprint 45 x 45 mm



10618300

BALMAIN
PARIS

OFFICE NOTEBOOK (A5 REF)

Cardboard covered with leatherette paper.

Luxury hard cover notebook with elastic closure and 96 sheets (80gsm) of lined paper, ideal for writing and sharing notes. Features an expandable pocket at the back to keep small notes. Incl. gift box.
13,5 x 2 x 21 cm

Compliance: Cadmium tested

Technique for decorated price: Screenprint 90 x 45 mm



10669400

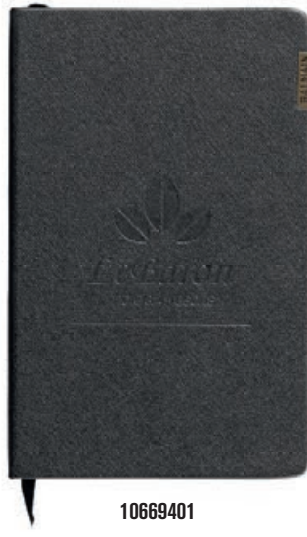

10669401



10669402



BALMAIN
PARIS

NOTEBOOK MIDI

Thermo PU.

When image matters, this exclusive design A5 size reference Balmain notebook ensures you'll make a good impression. High quality look and feel is finished with a Balmain logo plate. Features 80 sheets (80gms) of lined paper. Packed in a Balmain gift box.
21,1 x 13,5 x 1,5 cm

Compliance: PVC Free • Cadmium tested
Technique for decorated price: Screenprint 75 x 150 mm



New

BALMAIN
PARIS

BALMAIN NOTEBOOK (A5 SIZE)

Imitation Leather.

Exclusive design Balmain notebook (A5 size) featuring 80g, 80 sheets lined paper with interior back pocket and pen loop. Packed in a Balmain gift box. 21 x 14 cm

Compliance: Cadmium tested

Technique for decorated price: Screenprint 70 x 60 mm



10687200

New

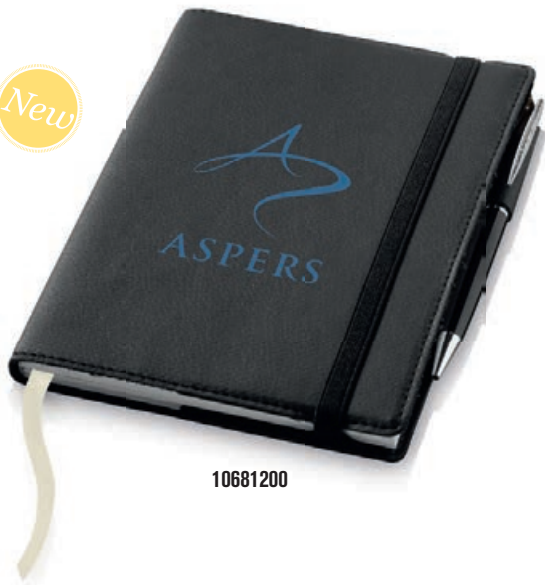

10681200



BALMAIN
PARIS

NEBULA NOTEBOOK GIFT SET

Cardboard and Imitation Leather.

Exclusive design flex cover notebook (80 sheets/80gsm lined cream paper) with integrated pen loop and business card insert at the inside of the back cover. An extra booklet is also included for making separate notes. Incl. twist mechanism ballpoint pen, both items packed in Balmain gift box. 19 x 13,3 x 1,5 cm

Compliance: Cadmium tested

Technique for decorated price: Screenprint 70 x 140 mm



BALMAIN
PARIS

NOTEBOOK GIFT SET

Thermo PU.

Exclusive design notebook (A5 reference) with Thermo PU cover, black ribbon page marker, magnetic closure and 80 sheets (80gsm) cream paper lined with gold edges. Incl. black with gold twist mechanism ballpoint pen, both items packed in Balmain gift box. Size notebook: 13,5 x 21,2cm. Length pen: 12,9cm. Diameter pen: 1,02cm. 23,5 x 18,2 x 3,2 cm

Compliance: MSDS • Cadmium tested

Technique for decorated price: Screenprint 50 x 150 mm



10655600
~~~~~

BALMAIN  
PARIS

### NOTEBOOK GIFT SET

**Thermo PU.**

Exclusive design notebook (A5 reference) with Thermo PU cover, 80 sheets (80gsm) cream paper lined with gold edges. Incl. twist mechanism ballpoint pen, both items packed in Balmain gift box. Size notebook: 13,2 x 21,3 cm. Length pen: 13,7cm. Diameter pen: 1,2cm. ø 1,3 x 14,8 cm

*Compliance: MSDS • Cadmium tested*

*Technique for decorated price: Screenprint 75 x 150 mm*



10654600  
~~~~~

1



2



3



4



5



What is Whitelines Link®?

Whitelines Link is a new technology. Use your new notepad and download the free app on App store or Google play. And transfer your analog notes to your computer or cell phone in a few seconds. Totally Automatic! Find out more ways to save time or work on; whitelines.se/link/creative-shortcuts

How to use Whitelines Link®

Write your notes with pen and paper, tick a quickbox for fast access to mail or your Dropbox or Evernote account. Scan with Whitelines Link App that automatically snaps the picture, cleans it from background supporting lines and straightens your text or picture to an upright position.

whitelines.se/link/creative-shortcuts



WHITELINES LINK®
The analog way to be connected.

WHITELINES LINK®
The analog way to be connected.

LINK FLEXOBOUND NOTEBOOK A5

Laminated paper.

Whitelines® Link is a combination of physical and digital notes connecting your notebook to your smartphone. With Whitelines® Link paper it is easy to capture, save and share your notes by downloading the special free app available for both iOS and Android. Features: Flexobinding, orange ribbon marker, 80 sheets lined paper perforated (80gsm). Incl. black gift box. Exclusive design.
21 x 16 cm

Compliance: Cadmium tested

Technique for decorated price: Padprint ø 70 mm



10667600

10667601

WHITELINES LINK®
The analog way to be connected.

LINK WIRED NOTEBOOK A5

Cardboard.

Whitelines® Link is a combination of physical and digital notes connecting your notebook to your smartphone. With Whitelines® Link paper it is easy to capture, save and share your notes by downloading the special free app available for both iOS and Android. Features: Wired binding, Elastic band, Accordeon pocket at the back, 80 sheets lined paper perforated (80gsm). Packed in black pouch. Exclusive design.
21,1 x 16,2 cm

Technique for decorated price: Screenprint 100 x 150 mm

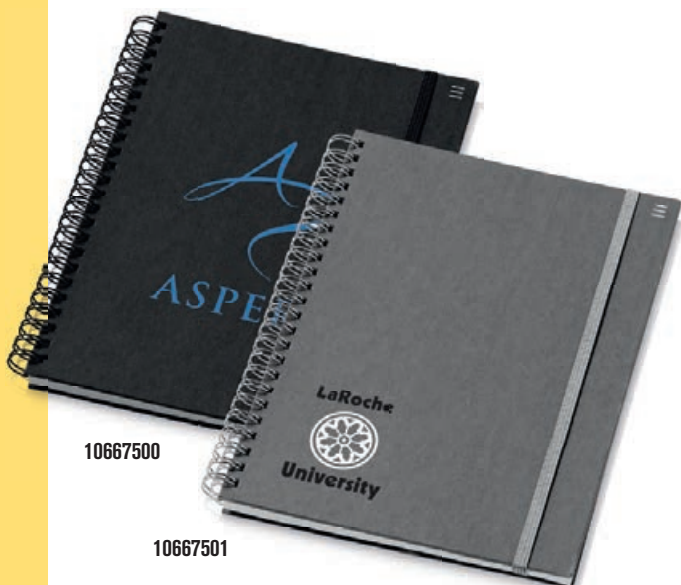

10667500

10667501

CARDIFF A4 ZIPPER PORTFOLIO

1200D polyester.

Portfolio with zipper closure, pen loop, document pockets and 20 pages lined notepad. Pen and accessoires not included. Packed in an Avenue giftbox. 27 x 34,5 x 2 cm

Compliance: Cadmium tested

Technique for decorated price: Screenprint 42 x 18 mm



19549317

CARDIFF A4 ZIPPER PORTFOLIO DELUXE

1200D polyester.

Exclusive design portfolio with zipper closure, ring binder, pen loop, document pockets and 20 pages lined notepad. Diameter ring binder is 2,5 cm. Packed in an Avenue gift box. Accessoires not included. ø 2,5 x 28 x 34 x 4 cm

Compliance: Cadmium tested

Technique for decorated price: Screenprint 42 x 18 mm



19549318



11947600

AMORD A4 ZIPPER PORTFOLIO

1680D nylon and imitation leather.

Exclusive design portfolio with extra attention to your personalization options. There is a special designed logo base that is ideal for doming. You can also choose to print or engrave the attached logo plate and fix this into the logo base. Both options will display your logo perfectly. Including 20 pages lined notepad. Packed in an Avenue gift box. Accessoires not included. 33 x 27 x 3 cm

Compliance: Cadmium tested

Technique for decorated price: Padprint 32 x 10 mm

Avenue

WAVE A4 ZIPPER PORTFOLIO

Imitation leather.

Exclusive design portfolio with zipper closure, pen loop, document pockets, inclusive a calculator and 20 pages lined note block. Packed in an Avenue gift box. Accessoires not included.

26 x 33 x 3 cm

*Compliance: EMC • WEEE • Battery Directive • RoHS
Technique for decorated price: Screenprint 110 x 200 mm*



11917500

Avenue

OXFORD A4 PORTFOLIO

Bonded leather.

Portfolio with pen loop and several pockets to store your documents. Includes a 20 pages lined note block. Pen and accessoires not included. Portfolio is packed in an Avenue giftbox.

24 x 31,5 x 1 cm

*Compliance: Cadmium tested
Technique for decorated price: Screenprint 140 x 200 mm*



19547360



19549724

Avenue

OXFORD A4 ZIPPER PORTFOLIO

Bonded leather.

Unique design portfolio with zipper closure and several pockets to store your documents. Including 20 pages lined note block. Packed in an Avenue gift box. Accessoires not included.

33,5 x 24,5 x 2,5 cm

*Compliance: Cadmium tested
Technique for decorated price: Screenprint 130 x 200 mm*



■ 11983900



■ 19547370



■■■ 11916300



■■■■ 11916400

Avenue

■ HARVARD LEATHER A5 PORTFOLIO

Split leather.

Unique design A5 portfolio with penloop and usb-loop, creditcard pockets and pocket to store your iPad. Including A5 size 20 pages lined note block. Packed in an Avenue gift box. Accessoires not included.
22,7 x 3 x 27,5 cm

Compliance: AZO • Formaldehyde • PCP • Cadmium tested
Technique for decorated price: Screenprint 100 x 100 mm

Avenue

■ HARVARD A4 LEATHER PORTFOLIO

Split leather.

Unique design portfolio with pen loop and several pockets to store your documents. Including 20 pages lined note block. Packed in an Avenue gift box. Accessoires not included.
24 x 31,5 x 1 cm

Compliance: Cadmium tested
Technique for decorated price: Screenprint 130 x 200 mm

Avenue

■■■ HARVARD A4 LEATHER ZIPPER PORTFOLIO

Split leather.

Unique design portfolio with zipper closure, pen loop and several pockets to store your documents. Including 20 pages lined note block. Packed in an Avenue gift box. Accessoires not included.
34 x 25 x 3,5 cm

Compliance: Cadmium tested
Technique for decorated price: Screenprint 120 x 200 mm

Avenue

■■■■ HARVARD A4 LEATHER ZIPPER PORTFOLIO DELUXE

Split leather.

Exclusive design portfolio with zipper closure, pen loop, ringbinder and several pockets to store your documents. Including 20 pages lined note block. Diameter of ring binder is 2,5 cm. Packed in an Avenue gift box. Accessoires not included.
34 x 25 x 4,55 cm

Compliance: Cadmium tested
Technique for decorated price: Screenprint 130 x 200 mm



11983700



12003000

MARKS M AN

MARKS M AN

ODYSSEY iPad MINI CASE

Tarpaulin.

Exclusive design iPad cover included a 20-pages lined notebook. Elastic loop to store your stylus or pen. With velcro closure and nylax lining that protects your tablet from scratches. Packed in a Marksman gift box. iPad and accessoires not included.
16 x 1,5 x 20,7 cm

Compliance: Cadmium tested
Technique for decorated price: Screenprint 85 x 85 mm

ODYSSEY iPad AIR CASE

Tarpaulin.

Exclusive design iPad air case protects your iPad air from scratches and smudges. Compatible for iPad air. Including 20 pages notebook. Packed in a Marksman gift box. iPad and accessoires not included.
18,5 x 1,5 x 24,8 cm

Compliance: Cadmium tested
Technique for decorated price: Screenprint 125 x 135 mm

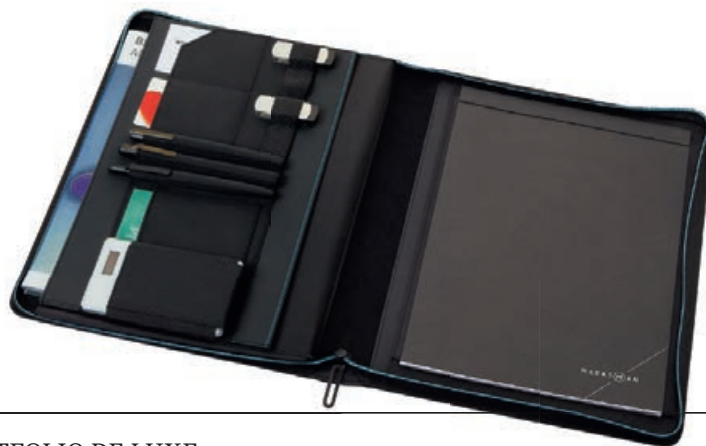

11972200

MARKS M AN

ODYSSEY PORTFOLIO DE LUXE

Tarpaulin.

Zippered portfolio with full organisation panel on the inside, document pocket and includes a 20 page notepad. Packed in a Marksman giftbox. Accessoires not included.
27 x 3,5 x 33 cm

Compliance: Cadmium tested
Technique for decorated price: Screenprint 150 x 150 mm



11954700

elleven

iPad CASE WITH A5 NOTEBOOK

Dot doobby nylon with scuba.

High tech exclusive design iPad case, suitable for iPad 1, 2, 3, 4 with zippered closure. TechTrap elastic interior organizer. Front cover pocket with business card holders. Notebook with 30 pages, 12.7 x 18.3 cm. Case is packed in a gift box. Accessoires not included.

28 x 21,5 x 3,7 cm

Compliance: Cadmium tested

Technique for decorated price: Screenprint 75 x 120 mm



11954600

elleven

iPad CASE WITH NOTEBOOK

Dot doobby nylon with scuba.

Unique design portfolio with zippered closure exclusive design portfolio. TechTrap elastic interior organiser. Holds a tablet. Front cover access pocket with business card holders and media organisers. Notebook with 30 pages, size 20.8 x 27.3 cm. Portfolio is packed in a gift box. Accessoires not included.

Compliance: Cadmium tested

Technique for decorated price: Screenprint 130 x 150 mm

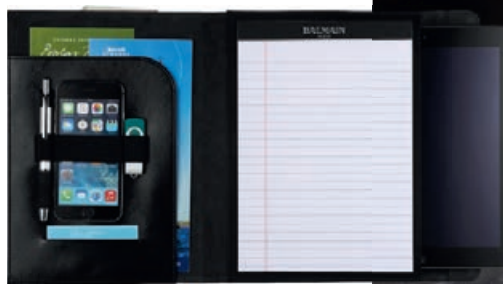

10682900

BALMAIN
PARIS

ABRUZZO PADFOLIO LARGE

Imitation leather.

Exclusive design padfolio with faux suede interior lining. Exterior flap with tab and loop closure. Interior tablet pocket accommodates up to 10" tablets including all versions of iPad Air and Samsung Galaxy. Scratch proof lining protects your tablet. Interior organizer with document pocket and business card slot. Elastic loops to hold a smartphone and (stylus) ballpoint pen. Includes 30 sheet writing pad. Packed in a Balmain gift box.

26,6 x 19,68 x 2,54 cm

Compliance: AZO • Cadmium tested

Technique for decorated price: Screenprint 80 x 200 mm





19985247

19985246

BALMAIN
PARIS

A4 ZIPPER PORTFOLIO

Imitation leather.

Unique design portfolio with zipper closure, pen loop and several pockets to store your documents. Includes notepad. Packed in a Balmain gift box. Accessoires not included.

27 x 33,5 x 3,5 cm

Compliance: Cadmium tested

Technique for decorated price: Screenprint 130 x 200 mm



BALMAIN
PARIS

11985000

PORTFOLIO

Nappa leather.

Luxury zipped Portfolio included notebook with gold colour accents and a pattern lining. The portfolio features two pen loops, a loop to store your memorystick and businesscard pockets. Packed in a Balmain giftbox. Accessoires not included.

25,5 x 2,5 x 34 cm

Compliance: Cadmium tested

Technique for decorated price: Debossing 80 x 80 mm

WRITING INSTRUMENTS

BY AVENUE





10676703

10676702

10676701

10676700

Avenue

DANLEY BALLPOINT PEN

Metal.

Combining a good solid feel with surprisingly affordable pricing, this simple ballpoint pen helps you make your mark without leaving a hole in your budget. Includes an Avenue pen gift box (size: 16 x 2.5 x 1.5cm).
ø 1 x 14 cm

*Compliance: MSDS • Cadmium tested
Recommended decoration: Padprint*

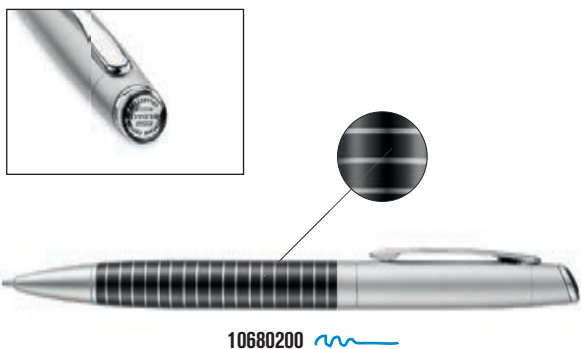

10680200

Avenue

AVERELL BALLPOINT PEN

Metal.

Striped patterning on the barrel gives this exclusively designed ballpoint pen a lively character. The top of the pen offers doming options. Incl. Avenue pen gift box (size: 16 x 2.5 x 1.5cm).
ø 1,1 x 13,8 cm

*Compliance: MSDS • Cadmium tested
Recommended decoration: Padprint*



10640401

10640400

Avenue

UPPSALA BALLPOINT PEN

Metal.

Classic, timeless design ballpoint pen with twist action mechanism. Incl. velvet pouch and Avenue gift box (size: 16 x 2.5 x 1.5cm).
ø 1,2 x 13,4 cm

*Compliance: MSDS • Cadmium tested
Recommended decoration: Engraving*



10601200



10601201

Avenue

GENEVA BALLPOINT PEN

Metal.

Sophisticated silhouette ballpoint pen featuring a matte upper barrel with shiny chrome lower barrel and matching chrome accents. Incl. velvet pouch and Avenue gift box (size: 16 x 2.5 x 1.5cm).
ø 1,5 x 13 cm

*Compliance: MSDS • Cadmium tested
Recommended decoration: Engraving*



10667100

Avenue

TRIANON BALLPOINT PEN

Metal.

Unique triangle shaped ballpoint pen. Each side of the ballpoint pen can be printed. Incl. Avenue gift box (size: 16 x 2.5 x 1.5cm).
 ø 1 x 14 cm

Compliance: MSDS • Cadmium tested
Recommended decoration: Padprint



10601400

10601401

Avenue

GENEVA ROLLERBALL PEN

Metal.

Sophisticated silhouette rollerball pen featuring a matte upper barrel with shiny chrome lower barrel and matching chrome accents. Incl. velvet pouch and Avenue gift box (size: 16 x 2.5 x 1.5cm).
 ø 1,5 x 13,5 cm

Compliance: MSDS • Cadmium tested
Recommended decoration: Padprint



10677000

Avenue

WILSON BALLPOINT PEN

Metal.

A block-patterned barrel adds distinctive character to this exclusive design ballpoint pen with PU leather wrap in the middle. Inclusive an Avenue gift box (size: 15.5 x 2.5 x 1.5cm).
 ø 1,05 x 14 cm

Compliance: MSDS • Cadmium tested
Recommended decoration: Padprint



10677300

Avenue

WILSON ROLLERBALL PEN

Metal.

A block-patterned barrel adds distinctive character to this rollerball pen with PU leather wrap in the middle. Inclusive an Avenue gift box (size: 15.5 x 2.5 x 1.5cm).
 ø 1,05 x 14 cm

Compliance: MSDS • Cadmium tested
Recommended decoration: Padprint



■ 10600400

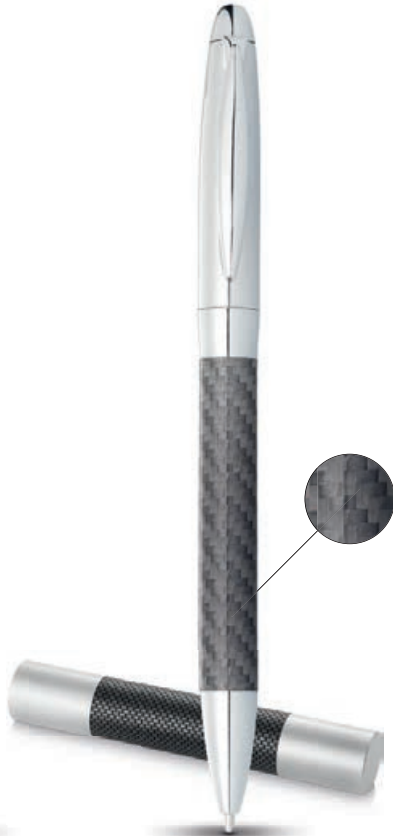

■ 10606800

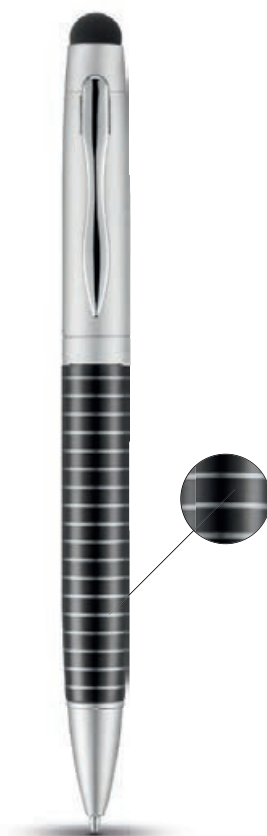

■ 10680300



■ 10666900



Avenue

■ CAPE TOWN BALLPOINT PEN

Metal.

Classic design ballpoint pen incl. Avenue gift box (size: 16 x 2.5 x 1.5cm).
ø 1 x 14 cm

*Compliance: MSDS • Cadmium tested
Recommended decoration: Engraving*

Avenue

■ AVERELL STYLUS BALLPOINT PEN

Striped patterning on the barrel gives this exclusively designed ballpoint pen and stylus combo a lively character. Incl. Avenue pen gift box.
ø 1,2 x 14 cm

*Compliance: MSDS • Cadmium tested
Recommended decoration: Padprint*

Avenue

■ WINONA BALLPOINT

Metal.

Classic design ballpoint with shiny upper barrel and carbon fibre details on lower barrel. Incl. cylinder gift box.
ø 2,6 x 16 cm

*Compliance: MSDS • Cadmium tested
Recommended decoration: Engraving*

Avenue

■ GENEVA STYLUS BALLPOINT PEN

Metal.

Sophisticated silhouette stylus ballpoint pen featuring a matte upper barrel with shiny chrome lower barrel and matching chrome accents. Incl. velvet pouch in Avenue gift box (size: 16 x 2.5 x 1.5cm).
ø 1 x 13,5 cm

*Compliance: MSDS • Cadmium tested
Recommended decoration: Engraving*



Avenue

Avenue

AMBRIA STYLUS BALLPOINT PEN

Metal.

Sleek look and solid feel come together in this handy ballpoint pen and stylus combo with rubber grip. Incl. Avenue gift box (size: 16 x 2,5 x 1,5cm).
 ø 1,01 x 14,5 cm

Compliance: MSDS • Cadmium tested
 Recommended decoration: Engraving

ALDEN STYLUS BALLPOINT PEN

Exclusive design stylus ballpoint pen featuring a high gloss barrel with an intricate, 3D geometric cut bottom barrel. Includes an Avenue gift box (size: 16 x 2,5 x 1,5cm).
 ø 1 x 13,9 cm

Compliance: MSDS • Cadmium tested
 Recommended decoration: Engraving



10632601

10632600

Avenue

Avenue

IDUAL STYLUS BALLPOINT PEN

Metal.

With this stylus ballpoint pen you can easily switch from writing notes on paper to navigating on your smartphone or tablet. Incl. Avenue gift box.
 ø 1,1 x 13 cm

Compliance: Cadmium tested
 Recommended decoration: Engraving



10675900

COLOR POP STYLUS BALLPOINT PEN

Metal.

Stylus ballpoint pen with 2 extra coloured stylus tips in 6mm and 8mm. Simply screw off the tip to switch size and/ or color. The 6mm tip is ideal for drawing, editing graphics and writing more precise on your smartphone or tablet. Incl. Avenue gift box.
 ø 0,96 x 12,5 cm

Compliance: MSDS • Cadmium tested
 Recommended decoration: Engraving



10669702



10669703



10669701



10669700



Avenue

BRAYDEN STYLUS BALLPOINT PEN

Metal.

With this stylus ballpoint pen you can easily switch from writing notes on the paper to navigation on your smartphone or tablet. Incl. Avenue pen gift box (size: 12.7 x 1.6 x 1.6cm).

ø 1,08 x 13,4 cm

Compliance: MSDS • Cadmium tested

Recommended decoration: Padprint

Avenue

TRIANON PEN SET

Metal.

Unique triangle shaped ballpoint pen and mechanical pencil set. Each side of the ballpoint pen can be printed. Incl. Avenue gift box (size: 16.9 x 5.2 x 2cm). ø 1 x 14 cm

Compliance: MSDS • Cadmium tested

Recommended decoration: Engraving



New

10682100



Avenue

OVAL BALLPOINT PEN SET

Metal.

Exclusive design pen set featuring a comfortable oval barrel in matte black with striking high polished chrome accents. Set includes a ballpoint and roller ball pen with premium quality black ink.

ø 0,9 x 14,3 cm

Compliance: Cadmium tested

Recommended decoration: Engraving



10667300



10667000



10677400



Avenue



GENEVA STYLUS BALLPOINT PEN AND ROLLERBALL PEN SET

Metal.

Sophisticated silhouette stylus ballpoint pen and rollerball pen featuring a matte upper barrel with shiny chrome lower barrel and matching chrome accents in Avenue sliding pen gift box (size: 16.9 x 5.2 x 2cm).
 ø 0,9 x 13,5 cm

Compliance: MSDS • Cadmium tested
 Recommended decoration: Engraving

Avenue



WILSON PEN SET

Metal.

A block-patterned barrel adds distinctive character to this exclusive design ballpoint and rollerball pen pair with PU leather wrap in the middle. Incl. Avenue pen gift box (size: 16.9 x 5.2 x 2cm).
 16,5 x 5 x 2 cm

Compliance: MSDS • Cadmium tested
 Recommended decoration: Padprint



10670802



10670809

10670810



10670804



10670812



10670803



10670808



10670806



10670801



10670800



10670811



10670805



10670807

MARKS MAN

LUNAR BALLPOINT PEN

Plastic.

Reliability takes on an adventurous twist in these quality pens which offer a great range of decoration possibilities. The distinctive 3-sided shape is available in a wide choice of colours and finishes. Longevity is assured through long-lasting Swiss-made Starminin refills. Incl. Marksman gift box. ø 1,2 x 14 cm

Compliance: MSDS • Cadmium tested
Recommended decoration: Padprint



MARKSMAN

RADAR BALLPOINT PEN

Plastic.

Ultra sleek soft-touch finish ballpoint pen with twist action mechanism. Exclusive Marksman design, incl. Swiss-made refill, Marksman cardboard penbox (size:15 x 2 x 1.5cm).
ø 1 x 14 cm

Compliance: MSDS • Cadmium tested
** Recommended decoration: Padprint



MARKSMAN

RADAR 2-IN-1 STYLUS

Aluminum and ABS.

Phone stand and stylus pen in one. The detachable stylus pen design ensures that both functions can be used at the same time. The innovative phone stand uses a standard 3,5mm headphone jack to hold your phone in the desired position. Packed in a Marksman gift box. Exclusive Design.
ø 1,1 x 7,9 cm

Compliance: Cadmium tested
Recommended decoration: Padprint

MARKSMAN

RADAR PEN GIFT SET

Unique matching ballpoint pen and stylus set for both writing and operating touch screen devices. Exclusive Marksman design, incl. Swiss-made refill and Marksman sliding gift box (size: 16.6 x 5.3 x 2.2cm).
ø 1 x 14 cm

Compliance: MSDS • Cadmium tested
** Recommended decoration: Padprint



10642907



10642901



10642902



10642900



10642905



10642904



10642903



MARKSMAN

CARVE BALLPOINT PEN

Maintaining the pen's smooth line by thoughtfully carving the clip out of the main barrel proves there's always another way of doing things. Exclusive Marksman design ballpoint pen with twist action mechanism, Swiss-made refill, Marksman cardboard penbox (size: 15 x 2 x 1.5cm).
 ø 1,2 x 14,6 cm

Compliance: MSDS • Cadmium tested
 Recommended decoration: Padprint



10642800



10642802



10642805



10642808



10642801



10642806



10642807



10642804



10642803



MARKSMAN

SMOOTH BALLPOINT PEN

Plastic and Metal.

The Smooth ballpoint pen with twist action mechanism is the perfect fusion of character and cool. This sleek operator blends functional components into a pleasingly design that's as smooth th touch as to write with. Exclusive Marksman design, incl. Swiss-made refill, Marksman cardboard penbox (size: 15 x 2 x 1.5cm).
 ø 1,1 x 14,5 cm

Compliance: MSDS • Cadmium tested
 Recommended decoration: Padprint



10653505

10653504

10653507

10653506

10653503

10653502

10653501

10653500

MARKSMAN

HYBRID BALLPOINT PEN

ABS Plastic and Metal.

Stylishly combining metal and plastic, this smartly designed ballpoint pen gives you the best of both worlds. Now, your only decision is the colour. Exclusive Marksman design, incl. Swiss-made refill, Marksman cardboard penbox (size: 15 x 2 x 1.5cm).
 ø 1 x 14,5 cm

*Compliance: MSDS • Cadmium tested
 Recommended decoration: Padprint*



10667400



MARKSMAN

EXPLORER BALLPOINT PEN

Metal and Acrylic.

Beautifully constructed with an attractive acrylic head incorporated in the innovative clip design, this bold go-getter is here to help you break new ground. Exclusive Marksman design. Incl. Swiss-made refill, Marksman penbox (size: 15 x 2 x 1.5cm).
 ø 1 x 14,8 cm

*Compliance: MSDS • Cadmium tested
 Recommended decoration: Padprint*



MARKS  AN

VOYAGER BALLPOINT PEN

ABS Plastic and Metal.

Exclusive design ballpoint with twist action mechanism. Incl. black folded giftbox.

ø 1,2 x 14,5 cm

Compliance: MSDS • Cadmium tested

Recommended decoration: Padprint



10653405

10653403

10653402

10653404

10653401

10653400

New



10686600

New



10686700

MARKS  AN

FIBER STYLUS BALLPOINT PEN

Metal.

Exclusive design stylus ballpoint pen with stylish knurled pattern. Subtle branding on clip and end tip paired with a durable fiber stylus tip ideal for all touch screens, including iPads, iPhones. Incl. premium black ink.

Recommended decoration: Padprint

MARKS  AN

FIBER STYLUS ROLLERBALL PEN

Metal.

Exclusive design stylus rollerball pen with stylish knurled pattern. Subtle branding on clip and end tip paired with a durable fiber stylus tip ideal for all touch screens, including iPads, iPhones. Incl. premium black ink.

Recommended decoration: Padprint

10659700
~



10659701
~

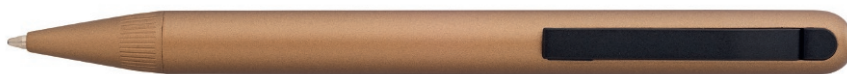

10659702
~



10659703
~



MARKS (M) AN

SMOOTH BALLPOINT PEN

Metal.

This luxury ballpoint pen with twist action mechanism is a sleek operator that blends functional components in a smooth design. Incl. Swiss-made refill and Marksman sliding gift box (size: 20 x 5 x 2.5cm). Exclusive Marksman design. ø 1,1 x 14,4 cm

*Compliance: MSDS • Cadmium tested
Recommended decoration: Padprint*



reddot design award
honourable mention 2013

10659800
~



10642600
~



MARKS (M) AN

TRIGON STYLUS BALLPOINT PEN

Metal.

Elegant twist action ballpoint pen with distinctive aqua blue accent and stylus tip for use on capacitive touch screens such as on smartphones and tablets. Exclusive Marksman design, incl. Marksman sliding gift box (size: 20 x 5 x 2.5cm). ø 1,2 x 14,5 cm

*Compliance: MSDS • Cadmium tested
Recommended decoration: Engraving*

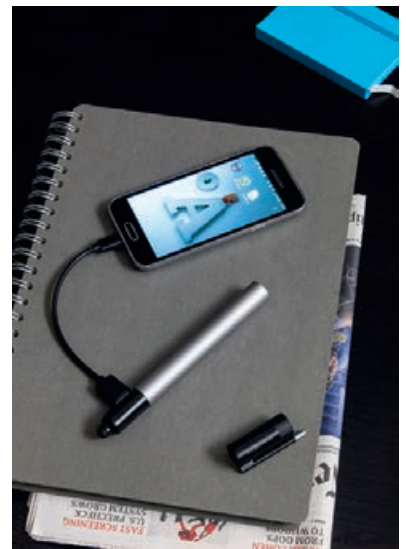

MARKSMAN

VOYAGER 3-IN-1 BALLPOINT PEN

Metal.

A perfectly compact synergy of electronic and traditional essentials, the Marksman Voyager powerbank stylus pen is an ABS/metal ballpoint pen that uniquely incorporates both a high-sensitivity touch screen stylus and a superhandy powerbank. Ingeniously saving space through its 3-in-1 functionality, this little gem can also save the day when mobile device batteries run down while on-the-go. The 700mAh battery capacity is enough for an emergency phone charge. The rubber tip stylus is ideal for operating a tablet or smartphone. All contained within an object that's only slightly larger than a regular ballpoint pen! Exclusive design packed in a Marksman gift box. ø 1,6 x 15,2 cm

Compliance: EMC • WEEE • Battery Directive • RoHS
Recommended decoration: Padprint

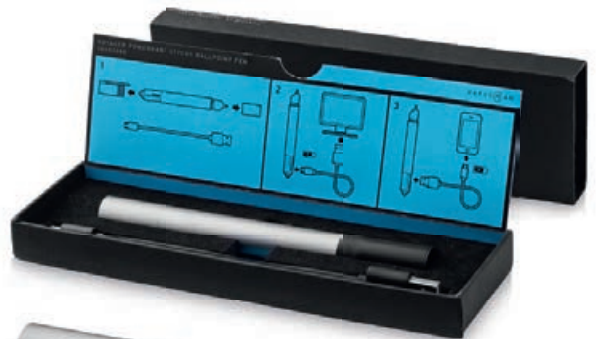

10682300



12346800

MARKSMAN

RADAR STYLUS BALLPOINT PEN AND LASERPRESENTER

Metal.

Exclusive Marksman design laser presenter with stylus and ballpoint pen presented in a Marksman gift box (size: 17 x 4,6 x 1,7cm). ø 1,1 x 14 cm

Compliance: EMC • WEEE • Battery Directive • LVD • RoHS • Cadmium tested
Recommended decoration: Padprint



BALMAIN
PARIS



10616800

BALMAIN
PARIS

PENCILS

Wood.

Exclusively designed chic pencil set in black colour with silver touch. 6 piece HB sharpened pencils in a luxury gift box.
19 x 6 x 1,2 cm

*Compliance: Formaldehyde • PCP • Cadmium tested
Recommended decoration: Screenprint*



10620200



10620201



10620202



BALMAIN
PARIS

BALLPOINT PEN

Metal.

Exclusive design ballpoint pen with luxurious velvet pouch in Balmain cardboard gift box (size: 17 x 3,5 x 2cm).
ø 0,9 x 14 cm

*Compliance: MSDS • Cadmium tested
Recommended decoration: Engraving*



10676600



BALMAIN
PARIS

ROLLERBALL PEN

Sleek look and solid feel come together in this exclusive design rollerball pen. The barrel is complemented with a tactile grip. Incl. premium black ink rollerball refill and packed in a Balmain gift box.
ø 1,3 x 14 cm

*Compliance: MSDS • Cadmium tested
Recommended decoration: Engraving*



10681900



10681901



BALMAIN
PARIS

BALLPOINT PEN

Metal.

Exclusive design lightweight ballpoint pen available in matt brushed gold finishing with gold coloured accents and matt brushed silver with chrome coloured accents. Incl. new style Balmain clip, premium Swiss quality black refill and packed in a Balmain gift box.
ø 1 x 13,3 cm

*Compliance: MSDS • Cadmium tested
Recommended decoration: Engraving*



BALLPOINT PEN

Metal.

Exclusive design ballpoint pen. Sophisticated silhouette features a chrome or coloured lower barrel with shiny chrome upper barrel and accents. Incl. new style Balmain clip, premium black ink refill and packed in a Balmain gift box. ø 0,96 x 13,6 cm

Compliance: MSDS • Cadmium tested
Recommended decoration: Engraving



BALLPOINT PEN

Metal.

Bearing all the hallmarks of a classic quality ballpoint pen, this ballpoint pen lets your writing flow freely and your words enjoy longevity on the paper. Swiss-made refill ensure this pen continues to deliver quality for many years. Incl. velvet pouch in Balmain cardboard gift box. ø 1,1 x 13,4 cm

Compliance: MSDS • Cadmium tested
Recommended decoration: Engraving



BALLPOINT PEN

Metal.

This elegantly styled capped exclusive design ballpoint pen embodies the Balmain charm and delivers uncompromised quality. Swiss-made refills provide superbly smooth writing action with ink that's made to last. Incl. velvet pouch in Balmain gift box. ø 1,1 x 14,1 cm

Compliance: MSDS • Cadmium tested
Recommended decoration: Engraving



■ 19982122
~~~~~



■ ■ 10670500  
~~~~~

New



■ ■ ■ 10682700
~~~~~



■ ■ ■ ■ 10633600  
~~~~~

BALMAIN
PARIS

BALMAIN
PARIS



■ BALLPOINT PEN

Metal and imitation leather.

Exclusive design luxury colour coated ballpoint pen with elegant imitation leather pouch in Balmain cardboard gift box (size: 15 x 3.5 x 2.5cm).
ø 1,3 x 14,2 cm

Compliance: MSDS • Cadmium tested
Recommended decoration: Engraving

■ ■ BALLPOINT PEN

Metal.

Distinctively styled with an embossed pattern on barrel and engraved details on the clip, this exclusive designed ballpoint pen is an attractive, high quality gift. Including Balmain gift box.
ø 1 x 13,7 cm

Compliance: MSDS • Cadmium tested
Recommended decoration: Engraving

BALMAIN
PARIS



BALMAIN
PARIS



■ ■ ■ BALLPOINT PEN

Metal and Imitation leather.

Exclusive design ballpoint pen with leather cross line pattern wrapped lower barrel and new style Balmain clip. Incl. premium black refill and packed in a Balmain gift box.
ø 1,29 x 13,6 cm

Compliance: MSDS • Cadmium tested
Recommended decoration: Engraving

■ ■ ■ ■ BALLPOINT PEN

Metal.

Exclusively designed luxury ballpoint pen presented in a lacquered Balmain gift box (size: 18 x 5.5 x 3cm).
ø 1 x 14 cm

Compliance: MSDS • Cadmium tested
Recommended decoration: Engraving



10641000 



BALMAIN
PARIS

BALLPOINT PEN

Metal.

This contemporary designer ballpoint pen with artistically sculpted clip is built to let your writing flow smoothly. Its Swiss-made refills deliver high-quality ink that continues to look good for a long, long time. Incl. Balmain rubbercoated paper cardboard gift box (size: 17.9 x 5.4 x 3cm).
ø 1,1 x 14 cm

*Compliance: MSDS • Cadmium tested
Recommended decoration: Padprint*



10609700 



BALMAIN
PARIS

BALLPOINT PEN

Metal and imitation leather.

Exclusive design stylish ballpoint pen with imitation leather pen pouch. Presented in a Balmain cardboard sliding gift box (size: 13 x 6.5 x 3cm).
ø 1,1 x 11,9 cm

*Compliance: MSDS • Cadmium tested
Recommended decoration: Engraving*



19982156 

19982158 



BALMAIN
PARIS

BALLPOINT PEN

Metal and imitation leather.

Exclusive design leather wrapped barrel ballpointpen with imitation leather pen pouch in Balmain gift box (size: 15 x 3.5 x 3cm).
1,1 x 13,9 cm

*Compliance: AZO • Formaldehyde • Cadmium tested
Recommended decoration: Engraving*

New



■ 10681400
~~~~~



■ 10680400  
~~~~~



■■■ 19982124
~~~~~



■■■■ 10633900  
~~~~~

BALMAIN
PARIS

■ ROLLERBALL PEN

Metal.

Exclusive design rollerball pen featuring a black coloured upper barrel combined with a contemporary striation pattern etched directly into the lower barrel. Incl. premium black rollerball ink refill and packed in a Balmain gift box.
Ø 1,15 x 14,1 cm

*Compliance: MSDS • Cadmium tested
Recommended decoration: Padprint*

BALMAIN
PARIS

■■■ BALLPOINT PEN

Metal.

Exclusive design ballpoint pen with soft touch grip presented in a Balmain gift box (size: 18 x 5 x 3,8cm).
1 x 13,4 cm

*Compliance: MSDS • Cadmium tested
Recommended decoration: Engraving*

BALMAIN
PARIS

■■ BALLPOINT PEN

Metal.

The perfect way to get your name etched into people's minds, this exclusive designed ballpoint pen has a beautifully etched barrel patterning and a dedicated place on the cap for printing your decoration. Incl. premium black ink refill and packed in a Balmain gift box.
Ø 1,17 x 14,1 cm

*Compliance: MSDS • Cadmium tested
Recommended decoration: Engraving*

BALMAIN
PARIS

■■■■ BALLPOINT PEN

Metal.

Exclusive design carbon fiber and metal twist action ballpoint pen. This ballpoint pen comes in a specially designed pouch in Balmain gift box (size: 15 x 3,2 x 2,3cm) to give that extra feeling once you receive this gift.
Ø 1 x 14 cm

*Compliance: MSDS • Cadmium tested
Recommended decoration: Engraving*

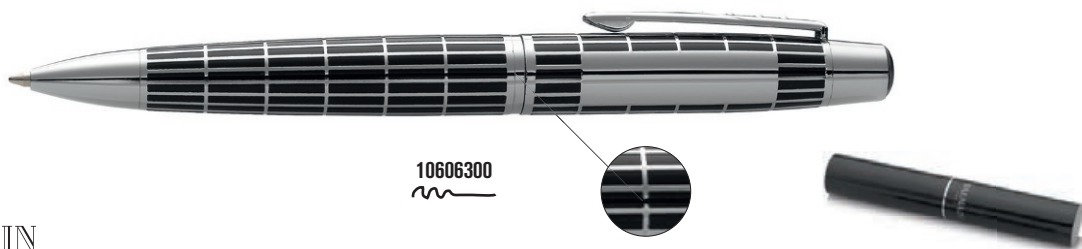

10606300

BALMAIN
PARIS

BALLPOINT PEN

Metal.

Exclusive design ballpoint pen with cylinder (diameter 2.6 cm, length 16cm) in Balmain gift box.
ø 1,2 x 13,7 cm

Compliance: MSDS • Cadmium tested
Recommended decoration: Engraving

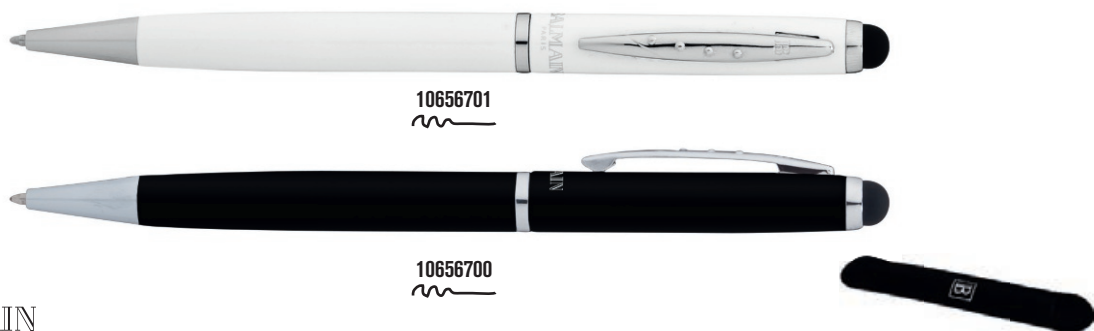

10656701

10656700

BALMAIN
PARIS

STYLUS BALLPOINT PEN

Metal.

Exclusive design twist action mechanism stylus ballpoint pen with velvet pouch. Incl. Balmain gift box (size: 17 x 3.5 x 2cm).
ø 0,9 x 13,6 cm

Compliance: MSDS • Cadmium tested
Recommended decoration: Engraving

Avenue's
Favourites

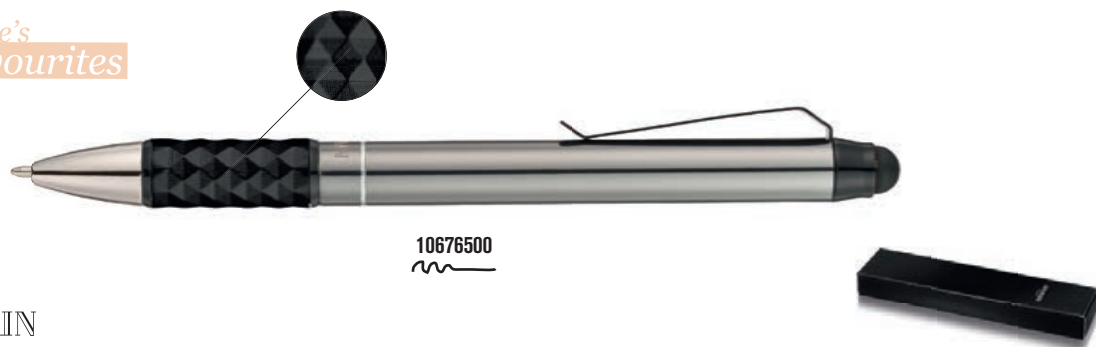

10676500

BALMAIN
PARIS

STYLUS BALLPOINT PEN

Sleek look and solid feel come together in this exclusive design ballpoint pen with stylus. The barrel is complemented with a tactile grip. Incl. premium black ink refill and packed in a Balmain gift box.
ø 1 x 14 cm

Compliance: MSDS • Cadmium tested
Recommended decoration: Engraving

New



10681700



10681701



10681702



10640800



10640801



10640802

BALMAIN
PARIS



BALMAIN
PARIS



STYLUS BALLPOINT PEN

Metal.

Exclusive design jotter style stylus ballpoint pen ideal for touch screen devices such as smartphones and tablets or retail payment pads. Incl. new style Balmain clip, black ink refill, pen pouch and Balmain gift box. ø 0,9 x 12 cm

Compliance: MSDS • Cadmium tested
Recommended decoration: Engraving

STYLUS BALLPOINT PEN

Metal.

Fashionable exclusive design ballpoint pen with twist action mechanism and stylus tip perfect for capacitive touch screen devices such as tablets and smartphones. Incl. lacquered Balmain gift box (size: 16 x 3.5 x 3cm). ø 0,9 x 12 cm

Compliance: MSDS • Cadmium tested
Recommended decoration: Engraving

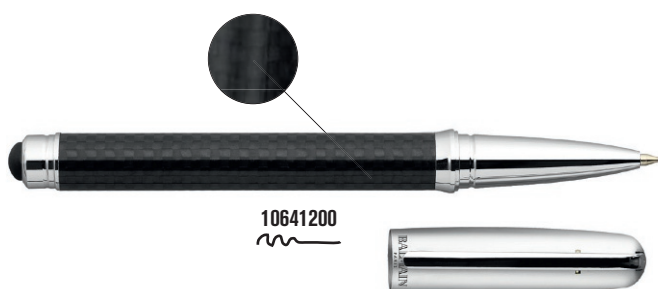

10641200



BALMAIN
PARIS

STYLUS ROLLERBALL PEN

Metal.

Traditional handcraft meets modern technology through this sleekly designed carbon fibre pen that incorporates both a quality rollerball pen and a stylus tip for touch screen devices. Incl. Balmain gift box (18 x 16.3 x 3cm). ø 1,1 x 14 cm

Compliance: MSDS • Cadmium tested
Recommended decoration: Padprint



BALMAIN
PARIS

BALLPOINT PEN GIFT SET

Metal.

Exclusive design ballpoint pen and rollerball pen set with Balmain cardboard gift box (size: 19 x 7,5 x 3cm).
ø 0,9 x 14 cm

*Compliance: MSDS • Cadmium tested
Recommended decoration: Engraving*



BALMAIN
PARIS

10682200
~



BALMAIN
PARIS

10682800
~

STYLUS BALLPOINT PEN SET

Metal.

Exclusive design pen set including a stylus ballpoint pen and roller ball pen. Both pens feature a graphite bottom barrel complemented with a polished chrome upper barrel. Incl. new style Balmain clip and Balmain detailing on middle ring. Premium black ink refill and rubberized stylus tip ideal for touchscreens such as tablets and smartphones. Incl. Balmain gift box.
ø 1 x 14 cm

*Compliance: MSDS • Cadmium tested
Recommended decoration: Engraving*

STYLUS BALLPOINT PEN GIFT SET

Metal.

Exclusive design pen set including a ballpoint and stylus ballpoint pen. Incl. premium black ink refill and Balmain gift box.
ø 0,96 x 13,8 cm

*Compliance: MSDS • Cadmium tested
Recommended decoration: Padprint*



BALMAIN
PARIS

BALLPOINT PEN GIFT SET

Metal.

The perfect way to get your name etched into people's minds, this exclusive designed ballpoint and rollerball pen pair have a beautifully etched barrel patterning and a dedicated place on the cap for printing your decoration. Incl. premium black ink refill and packed in a Balmain gift box.
16,5 x 6,5 x 2,8 cm

*Compliance: MSDS • Cadmium tested
Recommended decoration: Engraving*



BALMAIN
PARIS

BALLPOINT PEN GIFT SET

Metal and imitation leather.

Exclusive design elegant leather wrapped ballpoint and roller ball gift set with modern style contrast stitching. Includes an imitation leather double pen pouch in Balmain gift box.
16,5 x 6 x 2,2 cm

*Compliance: AZO • Formaldehyde • MSDS • Cadmium tested
Recommended decoration: Engraving*



BALMAIN
PARIS

BALLPOINT PEN GIFT SET

Metal.

Exclusively designed ballpoint and rollerball giftset in matching lacquered gift box. Incl. premium black ink refill.
18,5 x 8 x 4 cm

*Compliance: MSDS • Cadmium tested
Recommended decoration: Engraving*



19982130



10603200

BALMAIN
 PARIS

BALLPOINT PEN GIFT SET

Metal.

Exclusive modern design ballpoint and rollerball gift set presented in a Balmain leatherette paper gift box (size: 17.8 x 6.8 x 4cm).

1,4 x 14 cm

*Compliance: MSDS • Cadmium tested
 Recommended decoration: Engraving*

BALMAIN
 PARIS

BALLPOINT PEN GIFT SET

Metal.

Exclusive design ballpoint pen and rollerball pen set presented in a Balmain cardboard gift box (size: 18.7 x 7.8 x 6.7cm).

ø 1 x 13,5 cm

*Compliance: MSDS • Cadmium tested
 Recommended decoration: Engraving*



New

10681600

BALMAIN
 PARIS

BALLPOINT PEN GIFT SET

Metal.

Exclusive design pen set featuring a stylus ballpoint pen and roller ball with premium black ink refill. Soft rubber stylus tip is integrated into the end cap of ballpoint pen and eliminates fingerprints and smudges on your smartphone or tablet. Compatible with any capacitive touchscreen device. Also ideal for everyday use with public touchscreens such as ATM or retail payment pads. Incl. premium black ink refill and packed in a Balmain gift box.

ø 1,17 x 14,1 cm

*Compliance: MSDS • Cadmium tested
 Recommended decoration: Engraving*

BALLPOINT PEN GIFT SET

Metal.

Exclusive design ballpoint pen and rollerball pen with soft touch grip presented in a Balmain gift box (size: 17.8 x 6.8 x 4cm).
1 x 13,4 cm

Compliance: MSDS • Cadmium tested
Recommended decoration: Engraving



19982120



10670400



BALMAIN
PARIS

BALLPOINT PEN GIFT SET

Metal and Imitation leather.

Two essential items in one stylish gift set. The leather-wrapped ballpoint pen comes with a matching wallet. Exclusively designed and packed in a Balmain gift box (size: 14.8 x 13.8 x 2.8cm).
ø 1,2 x 13,9 cm

Compliance: MSDS • Cadmium tested
Recommended decoration: Engraving



10670300



BALMAIN
PARIS

BALLPOINT PEN GIFT SET

Metal and imitation leather.

For well-travelled executives, this exclusively designed pen and passport cover set is a stylishly practical gift. The high quality ballpoint pen has a shiny finish and engraved design feature on the cap. Packed in a Balmain gift box (size: 15.4 x 14.3 x 2.8cm).
ø 1,1 x 13,8 cm

Compliance: MSDS • Cadmium tested
Recommended decoration: Engraving





10627401

10627400

BALMAIN
PARIS

BALLPOINT PEN GIFT SET

Metal.

Exclusively designed stylish ballpoint pen and rollerball pen set with a contrast coloured edge pen pouch presented in a Balmain cardboard gift box (size: 17 x 6,5 x 2cm).
ø 1,2 x 13,4 cm

*Compliance: MSDS • Cadmium tested
Recommended decoration: Engraving*

*Avenue's
Favourites*



10669900

BALMAIN
PARIS

BALLPOINT PEN GIFT SET

Metal.

For a subtly different take on black, this exclusively designed pair of ballpoint and rollerball pens is finished in printed carbon fiber. Including quality protective pouch packed in Balmain gift box (size: 17.8 x 11.3 x 2.8cm).
ø 1,2 x 13,5 cm

*Compliance: MSDS • Cadmium tested
Recommended decoration: Engraving*



BALMAIN
PARIS

BALLPOINT PEN GIFT SET

Metal and imitation leather.

Exclusive design contrast stitching detail imitation leather pocket notebook (14 x 9,5cm) and leather wrapped barrel ballpoint. Includes matching Balmain gift box (size: 19 x 17 x 4cm).
ø 1,3 x 13,5 cm

Compliance: AZO • Formaldehyde • PCP • Cadmium tested
Recommended decoration: Engraving



10613300
~~~~~

BALMAIN  
PARIS

### BALLPOINT PEN GIFT SET

**Metal and imitation leather.**

Timeless pen set with ballpoint pen and notebook (14,3 x 9cm) with contrast colour stitching. Includes Balmain gift box (size: 18.1 x 17.2 x 4.4cm).  
Exclusive design.  
ø 1 x 13,6 cm

*Compliance: MSDS • Cadmium tested*  
*Recommended decoration: Engraving*



10627300  
~~~~~



19982150
~~~~~



BALMAIN  
PARIS

### BALLPOINT PEN GIFT SET

**Metal and imitation leather.**

Exclusive design gift set with a leather wrapped ballpoint, imitation leather keychain and wallet with creditcard pockets all featuring colour contrast white stitching. Presented in matching luxury Balmain gift box.  
19,3 x 16,3 x 3,5 cm

*Compliance: AZO • Formaldehyde • MSDS • Cadmium tested*  
*Recommended decoration: Screenprint*



19982152  
~~~~~



10627200



BALMAIN
PARIS

BALLPOINT PEN GIFT SET

Metal.

Exclusive design ballpoint pen and rollerball pen set with delicately etched line detail. Includes elegant carbon fibre look pouch (12.5 x 4.3cm) in a Balmain black gift box (size: 18.3 x 17.2 x 4.8cm).
ø 1 x 14 cm

Compliance: MSDS • Cadmium tested
Recommended decoration: Engraving



10670200



BALMAIN
PARIS

BALLPOINT PEN GIFT SET

Metal.

A small step away from the ordinary, this exclusively designed ballpoint and rollerball duo have a special finish that reflects Balmain's high class credentials. Including a quality protective pouch, packed in a Balmain gift box (size: 17.3 x 12.4 x 3cm).
ø 1,3 x 13,9 cm

Compliance: MSDS • Cadmium tested
Recommended decoration: Engraving



10609100



BALMAIN
PARIS

BALLPOINT PEN GIFT SET

Metal and imitation leather.

Exclusive designed set including a mechanical pencil, rollerball pen, ballpoint pen and matching imitation leather pen pouch (15.5 x 6cm) presented in a Balmain gift box (size: 18.5 x 17 x 3.5cm).
ø 1 x 13,5 cm

Compliance: MSDS • Cadmium tested
Recommended decoration: Engraving





10635900

BALMAIN
 PARIS

BALLPOINT PEN GIFT SET

Metal and Wood.

Exclusive design luxury wooden-style ballpoint pen and rollerball pen presented in a matching Balmain gift box (size: 18.5 x 9.8 x 5cm).
 ø 1,2 x 14 cm

*Compliance: MSDS • Cadmium tested
 Recommended decoration: Engraving*



10640901

10640900

BALMAIN
 PARIS

STYLUS BALLPOINT PEN GIFT SET

Metal.

Cover every eventuality with this thoughtfully exclusive designed gift set which includes a quality stylus ballpoint and a 4GB USB memory stick. Incl. lacquered Balmain gift box (size: 18.5 x 7.9 x 3.8cm).
 ø 0,9 x 12 cm

*Compliance: EMC • MSDS • RoHS
 Recommended decoration: Engraving*



10667800

BALMAIN
 PARIS

BALLPOINT PEN GIFT SET

Stainless Steel.

From personally handwritten notes to high-volume electronic data, this impressive exclusively designed gift set lets you record and share information with style. Includes a ballpoint pen and 4GB USB memory stick. Incl. lacquered Balmain gift box (size: 18.5 x 7.9 x 3.8cm).
 ø 7,9 x 18,5 cm

*Compliance: Battery Directive • MSDS • RoHS • Cadmium tested
 Recommended decoration: Engraving*



10623200

BALMAIN
PARIS

BALLPOINT PEN GIFT SET

Metal.

Exclusive design gift set including a rollerball pen and 4GB USB memory stick presented in a Balmain cardboard gift box (size: 17.5 x 7 x 3.5cm). 17,5 x 7 x 3 cm

Compliance: AZO • EMC • WEEE • MSDS • RoHS • Cadmium tested
Recommended decoration: Padprint

10682500

New



BALMAIN
PARIS

POWERBANK AND STYLUS PEN GIFT SET

Metal.

The Centaure gift set is the ultimate technology gift set. The sets includes a credit card size 3000mAh powerbank to charge your smartphone or other USB-powered devices and a stylus ballpoint pen for use on most touch screen devices. The powerbank features a 5v1a input/5v1a output and LED lights indicating the remaining battery power. A luxury pouch incl. space for business cards is included to take the powerbank along in style. Incl. Balmain gift box. 16 x 8,5 x 3 cm

Compliance: EMC • Battery Directive • RoHS • Cadmium tested
Recommended decoration: Engraving





PARKER



Write your own story



JOTTER

The Parker icon, Jotter, is the preferred choice for active writers who need pens wherever they go.

- Stainless steel trim.
- Classic and functional design



10647705



10647706



10647707



10647704



10647702
10647502



10647701
10647501



10647703
10647503



10647700
10647500

JOTTER BALLPOINT PEN

Plastic barrel with stainless steel trim.
ø 0,85 x 12,9 cm

Compliance: Cadmium tested
Recommended decoration: Screenround



■ 10647800 ■ 10647600



■ 10647900

■ JOTTER BALLPOINT PEN

Stainless Steel.
ø 0,085 x 12,9 cm

Compliance: Cadmium tested
Recommended decoration: Engraving

■ JOTTER MECHANICAL PENCIL

Stainless steel.
ø 0,85 x 13,3 cm

Compliance: Cadmium tested
Recommended decoration: Engraving



PARKER

VECTOR

Simple, essential and reliable, Vector is special with its adaptability and inherent quality.

- Total surface imprint possibility & Wrap Transfer Process.
- Manufactured from high-impact ABS plastic: long lasting, durable.



10648000



10648002



10648001

VECTOR BALLPOINT PEN

Plastic barrel with stainless steel trim.
ø 1 x 13,5 cm

Compliance: Cadmium tested
Recommended decoration: Screenround



10648301



10648302



10648300



VECTOR ROLLERBALL PEN

Plastic barrel with stainless steel trim.
ø 1 x 13,5 cm

Compliance: Cadmium tested
Recommended decoration: Screenround



■ 10648200

■■ 10648400



■ VECTOR BALLPOINT PEN

Stainless Steel.
ø 1 x 12,5 cm

Recommended decoration: Padprint

■■ VECTOR ROLLERBALL PEN

Stainless steel.
ø 1 x 13,3 cm

Compliance: Cadmium tested
Recommended decoration: Screenround

IM BALLPOINT

Parker IM's modern design offers timeless finishes successfully combining classic and contemporary styles. The finest grades of lustrous lacquer and chrome, and a highly engineered manufacturing process, ensure the Parker quality known worldwide.



■ ■
10648600



■ ■
10648601



■ ■
10648602



■ ■
10648603



■ ■
10648604



■ ■
10648606



■
10648701



■
10648700



■
10648702



■
10648704



■
10648705



■ ■
10648605



■
10648703

■ IM ROLLERBALL PEN

Metal.
ø 0,9 x 13,8 cm

Compliance: Cadmium tested
Recommended decoration: Padprint

■ ■ IM BALLPOINT PEN

Metal.
ø 0,9 x 13,6 cm

Compliance: Cadmium tested
Recommended decoration: Padprint



10648800



10648801



PARKER



IM FOUNTAIN PEN

Metal.

Parker IM's modern design executed in timeless black. The fine grade of lustrous lacquer and a highly engineered manufacturing process, ensure the Parker quality known worldwide. Incl. Parker gift box. Delivered with one ink cartridge. Exclusive design.

ø 0,9 x 13,8 cm

Compliance: Cadmium tested

Recommended decoration: Padprint



10675600



10675601



10675602



PARKER



IM PREMIUM BALLPOINT PEN

Aluminium chiseled.

Exclusive design glistening with delicate, feminine tones ballpoint pen available in Brown Shadow, Pink Pearl and Emerald pearl. Enhanced with subtle engraving, emulating the iconic striped Parker Vacumatic design. Complimented with golden finish trims. Incl. Parker gift box. Delivered with one ballpoint refill.

ø 1,2 x 13,6 cm

Compliance: Cadmium tested

Recommended decoration: Padprint



New

10683500



PARKER

IM DUO GIFT SET BRUSHED METAL

Metal.

Parker IM's modern design successfully combines classic and contemporary styles. The finest grades of lustrous lacquer and chrome, and a highly engineered manufacturing process, ensure the Parker quality known worldwide. This exclusive design gift box set combines the IM Ballpoint pen Brushed metal (10648603) with the IM rollerball pen (10648703).
21,5 x 14,3 x 3,8 cm

*Compliance: MSDS • Cadmium tested
Recommended decoration: Engraving*



New

10683600



PARKER

IM DUO GIFT SET BLACK CT

Metal.

Parker IM's modern design successfully combines classic and contemporary styles. The finest grades of lustrous lacquer and chrome, and a highly engineered manufacturing process, ensure the Parker quality known worldwide. This exclusive design gift box set combines the IM Ballpoint Black CT (10648601) with the IM Fountain pen (10648800).
21,5 x 14,3 x 3,8 cm

*Compliance: MSDS • Cadmium tested
Recommended decoration: Engraving*



10648903

10648901

10648905

10648900

10648904

10648902

10648906



PARKER

URBAN BALLPOINT PEN

Metal.

Cool, new generation pen that redefines modern writing and reinvents the rules. It combines ergonomics with art, to give an unconventional bullet shape with perfect weight and balance. Incl. Parker gift box. Delivered with one ballpoint refill.

ø 1,2 x 14 cm

*Compliance: Cadmium tested
Recommended decoration: Engraving*



New



10683100

New



10683700



PARKER

URBAN GIFT SET

Metal.

This beautiful gift set combines the Urban ballpoint pen (10648903)/ (10648906) with a pen pouch. Exclusive design. Delivered with one ballpoint refill.

20,5 x 14,3 x 4,5 cm

*Compliance: MSDS • Cadmium tested
Recommended decoration: Engraving*



PARKER

URBAN

Cool, new generation pen that redefines modern writing and reinvents the rules. It combines ergonomics with art, to give an unconventional bullet shape with perfect weight and balance.

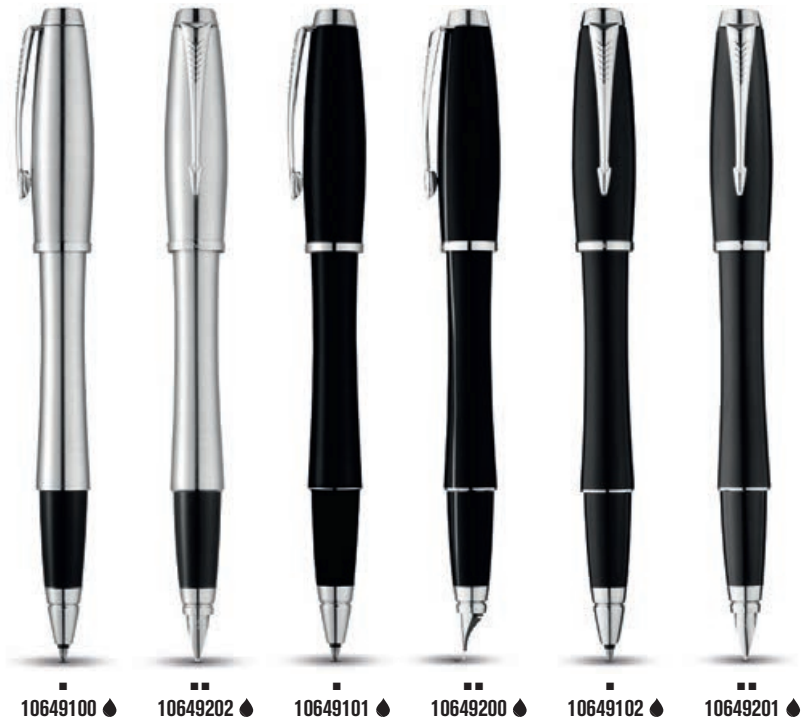

■ 10649100

■ 10649202

■ 10649101

■ 10649200

■ 10649102

■ 10649201

■ URBAN ROLLERBALL PEN

Metal.
ø 1,1 x 14 cm

Compliance: Cadmium tested
Recommended decoration: Engraving

■ URBAN FOUNTAIN PEN

Metal.
ø 1,1 x 13,82 cm

Compliance: Cadmium tested
Recommended decoration: Engraving



10675300



10675301



PARKER

URBAN PREMIUM BALLPOINT PEN

Aluminium chiseled.
Exclusive design ballpoint pen available in Golden Pearl with polished gold trims and Silver Blue Pearl with polished chrome trims. Enhanced with subtle engraving, emulating the iconic striped Parker Vacumatic design. Incl. Parker gift box. Delivered with one ballpoint refill.
ø 1,2 x 14 cm

Compliance: Cadmium tested
Recommended decoration: Engraving



10649303



10649304



10649302



10649400



10649401



10649402



PARKER



PARKER



URBAN PREMIUM BALLPOINT PEN

Lacquered and chiseled.

Urban Premium is highlighted by a set of trendy finishes with a matt or metallic rendering. Both men and women will enjoy its perfectly balanced silhouette emphasized by a unique graphic decor. Incl. Parker gift box. Delivered with one ballpoint refill. Exclusive design.
ø 1,1 x 13,82 cm

Compliance: Cadmium tested
Recommended decoration: Engraving

URBAN PREMIUM ROLLERBALL PEN

Lacquered and chiseled.

Urban Premium is highlighted by a set of trendy finishes with a matt or metallic rendering. Both men and women will enjoy its perfectly balanced silhouette emphasized by a unique graphic decor. Incl. Parker gift box. Delivered with one rollerball refill. Exclusive design.
ø 1,1 x 13,8 cm

Compliance: Cadmium tested
Recommended decoration: Engraving

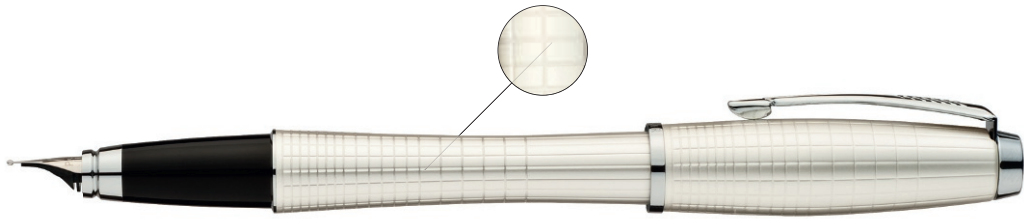

10649502



URBAN PREMIUM FOUNTAIN PEN

Lacquered and chiseled.

Urban Premium is highlighted by a set of trendy finishes with a matt or metallic rendering. Both men and women will enjoy its perfectly balanced silhouette emphasized by a unique graphic decor. Incl. Parker gift box. Delivered with one ink cartridge. Exclusive design.
 ø 1,1 x 13,8 cm

*Compliance: Cadmium tested
 Recommended decoration: Engraving*

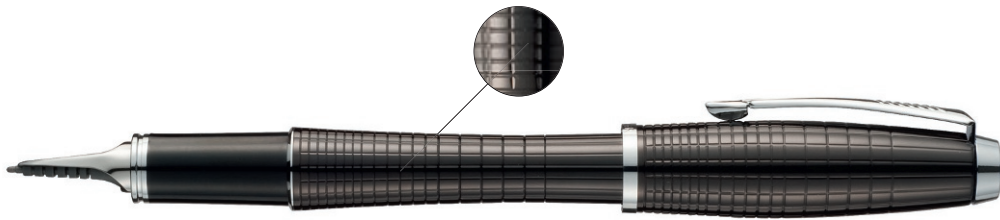

10649600



10649601



URBAN PREMIUM PARKER 5TH

Lacquered and chiseled.

The Parker Urban Premium 5th redefines modern writing and reinvents the rules. The Parker 5th Technology, so named because it offers a genuine fifth way of writing, was born of extensive research to bring the best into the pen world. The result of this ground-breaking innovation is an effortlessly smooth, smart gliding feeling that adjusts to your writing style after only a few words. Incl. Parker gift box. Delivered with one ink cartridge. Exclusive design.
 ø 1,1 x 13,8 cm

*Compliance: Cadmium tested
 Recommended decoration: Engraving*



PARKER

SONNET

The Parker Sonnet is modern pen design at its best - the definitive Parker style.

- Precision engineered reliability and smooth performance
- Sumptuous finishes & exquisite details

New



10686301



10686302



10686300



PARKER

SONNET EXPECTATIONS ROLLERBALL PEN

Metal.

Compliance: Cadmium tested



New



10686201



10686202



10686200



PARKER

SONNET EXPECTATIONS BALLPOINT PEN

Metal.

Compliance: Cadmium tested



SONNET

The Parker Sonnet is modern pen design at its best - the definitive Parker style.

- Precision engineered reliability and smooth performance
- Sumptuous finishes & exquisite details



■ 10650001

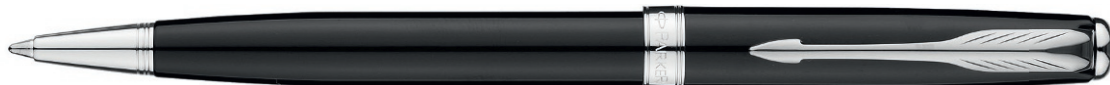

■ ■ 10650000



■ ■ 10650002



■ SONNET BALLPOINT PEN

Stainless Steel.

Ø 1,2 x 13,7 cm

Compliance: Cadmium tested

Recommended decoration: Engraving

■ ■ SONNET BALLPOINT PEN

Lacquered. Silver Plated.

Ø 1,2 x 13,7 cm

Compliance: Cadmium tested

Recommended decoration: Engraving



New

10683300



New

10683400

SONNET GIFT SET

Lacquered.

The Parker Sonnet is modern design at its best - the definitive Parker style. This exclusive design beautiful gift box set combines the Parker Sonnet Black GT (10650002) / Black CT (10650000) with a luxury pen pouch. Delivered with a premium Parker quality black refill.

20,5 x 14,3 x 4,5 cm

Compliance: MSDS • Cadmium tested

Recommended decoration: Engraving



■ 10650100 ◆



■ ■ 10650400 ◆



■ ■ ■ 10650300 ◆



■ ■ ■ 10650301 ◆



PARKER

■ SONNET ROLLERBALL PEN

Stainless steel.

The Parker Sonnet is modern pen design at its best - the definitive Parker style. Precision engineered reliability and smooth performance combined with sumptuous finishes and exquisite details. Incl. Parker gift box. Delivered with one rollerball refill. Exclusive design.
ø 1,2 x 13,3 cm

*Compliance: Cadmium tested
Recommended decoration: Padprint*

■ ■ SONNET FOUNTAIN PEN

Stainless Steel.

ø 1,2 x 13,3 cm

*Compliance: Cadmium tested
Recommended decoration: Engraving*

■ ■ ■ SONNET FOUNTAIN PEN

Lacquered. Gold Plated.

ø 1,2 x 13,3 cm

*Compliance: Cadmium tested
Recommended decoration: Engraving*

■ 10674700



■ ■ 10674701



PARKER

INGENUITY PARKER 5TH

The Parker Ingenuity range offers a wide variety of graceful designs, giving you a smooth and flowing writing experience. The Parker 5th technology combines the best aspects of ballpoint pens and fountain pens to create a truly innovative luxury pen. Incl. Parker gift box and one 5th cartridge. Exclusive design.



■ **Lacquered.**

ø 1,4 x 13,9 cm

Compliance: Cadmium tested

Recommended decoration: Padprint

■ ■ **Rubber and metal.**

ø 1,4 x 13,9 cm

Compliance: Cadmium tested

Recommended decoration: Engraving

10674602



10674600



10674601



10674603



10674604



PARKER

DUOFOLD PREMIUM BALLPOINT PEN

Lacquered.

Delicately crafted exclusive design ballpoint pen with highly distinguished, contrasting golden trims. Incl. Parker gift box and delivered with one ballpoint refill.

ø 1,1 x 13,3 cm

Compliance: Cadmium tested

Recommended decoration: Padprint

WATERMAN

PARIS



GRADUATE

Based on a classic design, Graduate is resolutely functional and modern. Graduate is ideal for everyday use or for gift giving occasions.



■ GRADUATE BALLPOINT PEN

Stainless Steel.

ø 1,1 x 13,9 cm

Compliance: Cadmium tested

Recommended decoration: Engraving

■ ■ GRADUATE ROLLERBALL PEN

Stainless Steel.

ø 1,1 x 13,6 cm

Compliance: Cadmium tested

Recommended decoration: Engraving

■ ■ ■ GRADUATE FOUNTAIN PEN

Stainless Steel.

ø 1,1 x 13,6 cm

Compliance: Cadmium tested

Recommended decoration: Engraving



■ 10651600



■ 10651601



■ ■ 10651700

HÉMISPHERE

A pure, simple, timeless line. Hémisphère – both highly practical and discreet – slides, unnoticed, into a pocket, bag or diary. A design that combines natural, seductive elegance with true magnetism.



■ HÉMISPHERE BALLPOINT PEN

Stainless steel.

ø 1 x 13,6 cm

Compliance: MSDS • Cadmium tested

Recommended decoration: Engraving

■ ■ HÉMISPHERE MECHANICAL PENCIL

Stainless steel.

ø 1,05 x 13,7 cm

Compliance: Cadmium tested

Recommended decoration: Engraving



10651103

10672400

10651102

10651100

10651101

10651105

10651104

HÉMISPHERE BALLPOINT PEN

Lacquered.
 ø 1 x 13,6 cm

Compliance: Cadmium tested
Recommended decoration: Engraving



■ 10651400

■ 10651402

■ 10672500

■ 10651401

■ 10651501

■ 10651500

■ HÉMISPHERE ROLLERBALL PEN

Lacquered.
 ø 1,05 x 13,7 cm

Compliance: Cadmium tested
Recommended decoration: Engraving

■ HÉMISPHERE ROLLERBALL PEN

Stainless steel.
 ø 1,05 x 13,7 cm

Compliance: Cadmium tested
Recommended decoration: Engraving



■ 10651200



■ 10651201



■ 10651202



■ 10651300



■ 10651301



■ HÉMISPHERE FOUNTAIN PEN.

Lacquered.
ø 1,05 x 13,8 cm

Compliance: Cadmium tested
Recommended decoration: Engraving

■ HÉMISPHERE FOUNTAIN PEN

Stainless steel.
ø 1,05 x 13,7 cm

Compliance: Cadmium tested
Recommended decoration: Padprint

EXPERT

The Expert New Generation Collection is the perfect bold accomplice for the spirit of self-expression. This collection sees daring new colour choices, Taube and Deep Brown, meet iconic design to create the ultimate sophisticated business style with a highly personalized twist.



■ 10650500



■ 10650504



■ 10650505



■ ■ 10650502



■ ■ 10650503



■ EXPERT BALLPOINT PEN

Lacquered.
ø 1,1 x 14,2 cm

Compliance: Cadmium tested
Recommended decoration: Engraving

■ ■ EXPERT BALLPOINT PEN

Stainless Steel.
ø 1,1 x 14,2 cm

Compliance: Cadmium tested
Recommended decoration: Engraving



■ 10650601 ◆

■ 10650605 ◆

■ EXPERT ROLLERBALL PEN

Lacquered.
 ø 1,3 x 17,6 cm

Compliance: Cadmium tested
Recommended decoration: Engraving



■ 10650602 ◆

■ EXPERT ROLLERBALL PEN

Stainless steel.
 ø 1,3 x 17,6 x 30 cm

Compliance: Cadmium tested
Recommended decoration: Engraving



10650702 ◆



10650700 ◆



EXPERT FOUNTAIN PEN

Lacquered.
 ø 1,3 x 17,5 cm

Compliance: Cadmium tested
Recommended decoration: Engraving



10672601 



10672600 



WATERMAN
PARIS

EXPERT DE LUXE BALLPOINT PEN

Lacquered and chiseled.

Ø 1,1 x 14,2 cm

Compliance: Cadmium tested

Recommended decoration: Padprint



10683200

WATERMAN
PARIS

EXPERT GIFT SET BLACK CT

Lacquered.

Expert brings smart Parisian styling to your business day. With its generous cigar-shaped silhouette and wealth of fine materials, it reveals that beneath your executive persona stirs a creative spirit. This beautiful gift box set combines the Waterman Expert Matt Black ballpoint pen (10650504) and a luxury pouch. Delivered with one ballpoint refill. Exclusive design.

4,5 x 14,3 x 20,5 cm

Compliance: MSDS • Cadmium tested

Recommended decoration: Engraving

CARÈNE

The most distinguished Waterman. A satin or gloss lacquered barrel, an 18-carat solid gold rhodium-plated nib and silver-plated trims all offer a truly modern look.



■
10672700



■
10651800



■■
10672800



■■
10651900



■■■
10672900



■■■■
10652001

■ CARÈNE BALLPOINT PEN

Lacquered.
ø 1,4 x 13,8 cm

Compliance: Cadmium tested
Recommended decoration: Engraving

■■ CARENE ROLLERBALL PEN

Lacquered.
ø 1,4 x 13,8 cm

Compliance: Cadmium tested
Recommended decoration: Engraving

■■■ CARÈNE FOUNTAIN PEN

Lacquered.
ø 1,3 x 14,5 cm

Compliance: Cadmium tested
Recommended decoration: Engraving

■■■■ CARÈNE FOUNTAIN PEN

Lacquered.
ø 1,4 x 13,8 cm

Compliance: Cadmium tested
Recommended decoration: Engraving



rotring
Germany 1928

10652600



10652602



rOtring
Germany 1928

TIKKY BALLPOINT PEN

Plastic.

Tikky, the entry to rOtring in smooth ball point mode. Ergonomic wave-form grip area gives great control. Smooth ball point writing. Perfect for precise writing and drawing needs. Incl. rOtring gift box. Delivered with one ballpoint refill. Exclusive design.
ø 0,85 x 13,8 cm

Compliance: Cadmium tested
Recommended decoration: Padprint

10652702



10652701



10652703



10652704



10652705



10652706



rOtring
Germany 1928

TIKKY MECHANICAL PENCIL.

Plastic.

Light-weight mechanical pencil (0.5mm nib) with rubberised grip to create sketches, technical drawings and texts cleanly and precisely. Hi-Polymer leads ensure high flexibility and durability while keeping the lead support tip clean. Built-in eraser under the push-button cap. Incl. rOtring gift box. Delivered with pencil refill. Exclusive design.
ø 0,85 x 13,8 cm

Compliance: Cadmium tested
Recommended decoration: Padprint

10652800



10652801



rOtring
Germany 1928

TIKKY MULTIPEN

Plastic.

Multifunctional pen with rubberised grip and "magic view" mechanism turning it optionally into a pencil (0.7mm nib) or ballpoint pen to sketch, write or highlight. Just hold the pen in your hand, look at the desired mode icon and press the push button. Eraser included under the push-button cap. Incl. rOtring gift box. Delivered with refills. Exclusive design.
ø 0,85 x 14,75 cm

Compliance: Cadmium tested
Recommended decoration: Padprint

10652101



10652100



rOtring
Germany 1928

MADRID BALLPOINT PEN

Metal.

Where visual appearance and precision count, the Madrid series stands out. With its intelligent design and subtle mechanism, it is the ideal tool for the creative amongst us. Incl. rOtring gift box. Delivered with one ballpoint refill. Exclusive design.
ø 0,9 x 13,4 cm

Compliance: Cadmium tested
Recommended decoration: Engraving



10652200

10652201

10652500

10652501

rtring
Germany 1928



■ MADRID MECHANICAL PENCIL

Metal.

Where visual appearance and precision count, the Madrid series stands out. With its intelligent design and subtle mechanism, it is the ideal tool for the creative amongst us. Incl. rOtring gift box. Delivered with pencil refill (0.7mm nib). Exclusive design.

ø 0,9 x 13,7 cm

*Compliance: Cadmium tested
Recommended decoration: Engraving*

rtring
Germany 1928



■■■ RAPID PRO BALLPOINT PEN

Metal.

The perfect professional tool for all sketching, writing and drawing applications. Solid metal, hexagonal barrel shape and the knurled grip underline its technical expertise. The ballpoint pen is equipped with document proof blue giant refill. Incl. rOtring gift box. Delivered with one ballpoint refill. Exclusive design.

ø 0,85 x 14,5 cm

*Compliance: Cadmium tested
Recommended decoration: Engraving*



10652300

10652301

10652400

10652401

rtring
Germany 1928



■■ DUBAI BALLPOINT PEN.

Metal.

The Dubai is an all-purpose ballpoint pen. The price performance ratio is remarkable: high quality materials have been used offering great performance. Incl. rOtring gift box. Delivered with ballpoint refill. Exclusive design.

ø 0,9 x 13,77 cm

Recommended decoration: Engraving

rtring
Germany 1928



■■■■ RAPID PRO MECHANICAL PENCIL

Metal.

Mechanical pencil (0.7mm nib) with full metal body and non-slip metal knurled grip equipped with a unique cushion point mechanism to improve control, comfort and reduce lead breakages. Built-in eraser under the push-button cap. Incl. rOtring gift box. Delivered with pencil refill. Exclusive design.

ø 0,9 x 14,5 cm

*Compliance: Cadmium tested
Recommended decoration: Engraving*

DECORATION INFORMATION



DEBOSSING

Debossing creates an indented image by applying a die to heat-pressed area.

- Create a unique 3D look
- Subtle tone on tone look
- Adds perceived value
- Great for real and imitaion leather product



LASER ENGRAVING

Laser engraving is achieved through using a laser beam to precisely etch decoration into a surface.

- Create a high-class impression
- Unique tone on tone
- Superb result for metal, glass and wood



HOTSTAMPING

Hot stamping is debossing with a metallic finish, created by applying foil between the to-be-decorated surface and the dye.

- Exceptional superior impression
- Create a unique 3D look
- Ideal for real and imitaion leather product
- Available in silver and gold finish



EMBROIDERY

Embroidery is decorating a fabric by stitching thread in a pattern.

- Classic decoration technique
- High value look
- Suitable for both flat and irregular surfaces
- Tread colours to match any logo
- Up to 12 colours per embroidery
- High impact wool stitch



SUBLIMATION

Sublimation is a printing method where ink is heated to turn into gas and form a permanent bond with the to-be-decorated material.

- Premium full-colour photorealistic prints
- Suitable for polyester fabrics (minimum 60% polyester) and polymer coated products
- Soft, flexible imprint that can even be applied over seams and zips
- Decoration is resistant to fading and cracking
- Only suitable for white products



DOMING

Doming is used to create a 3D version of your image by shaping a raised surface beneath the print. A mould is formed, printed and filled with epoxy which is then hardened to maintain its shape.

- Create a 3D effect
- Strong resistance to fading or damage
- Can only be applied to flat surfaces



TRANSFER

Transferring is done by first creating a screen print image on paper and then using heat and glue to transfer it onto the chosen article.

- Ideal for fabrics
- Perfect for logos with many colours
- Allows for extreme detail like small text
- Free standing text
- No contours required
- Economical solution for multicolour printing of smaller quantities



SCREENROUND

Screen round is based on the same method as screen print but the product is turned during the printing proces, making this method suitable for curved surfaces.

- Long lasting results
- Apply sharp, high-quality decoration on curved products
- Economic choice for large quantities
- Multi-colour decoration available on a selection of pens
- Ideal for text



SCREENPRINT

Screen printing or silk screen is a printing method where the image is imposed on a mesh screen with blank areas coated with an impermeable substance. Inks are then pressed through the mesh screen to produce clear, sharp images.

- Long lasting results
- Good cost-effective solution for larger quantities
- Allows single and multi-colour decorations
- Ideal for text
- Can only be applied to flat surfaces



PADPRINT

Pad printing or tampon printing is an indirect offset printing process that involves ink being transferred from a engraved metal plate via a silicone pad onto the product creating the image.

- Great all-round cost-effective solution
- Can be applied on virtually any shape
- Suitable for any surface texture, including soft products like stress balls
- Perfect for multi coloured logos
- Fast and economical



DIGITAL PRINTING

Digital printing is similar to inkjet printing. Micro droplets of ink are squirted onto a product to create an image. The ink is instantly cured by exposing it to UV light.

- Perfect for multi coloured logos
- Create a unique effect with matt, gloss or embossed finishes
- Strong resistance to fading or damage
- Ideal for small quantities
- Can only be applied to flat or slightly curved surfaces



707.....	150	Flasks.....	207, 210, 212, 214	Power banks.....	14, 28-32, 35, 162, 246, 263
A		Footballs.....	135	R	
Aerators.....	174-176, 202	Fountain pens.....	268-269, 271, 273, 277, 280, 282, 284-285	Radios.....	19
Alarm clocks.....	19	G		RFID wallets.....	116
Amplifiers.....	12-17, 212	Games (indoor).....	136	Rollerball pens.....	235, 239, 244, 248, 252, 254-259, 261-263, 266-267, 269, 271-272, 274-275, 277, 280-281, 283
Amuse bouche sets.....	180	Glasses (drinkware).....	190-191, 204	Rotring.....	288-289
Appetiser sets.....	180, 193	H		Rucksacks.....	45-46, 48, 51-55, 60, 67-70, 73-79, 81, 84-86, 88-93, 95, 99-102, 104-106
Aprons.....	192	Headphones.....	20	S	
Avenue.....	12-15, 19-22, 24-25, 28-31, 34-36, 38-39, 44-63, 117, 133, 138-139, 150, 174-181, 185, 207-213, 227-229, 234-239	I		Sailor bags.....	89, 95
B		Ice scrapers.....	155	Salt mills.....	200
Backpacks.....	45-46, 48, 51-55, 60, 67-70, 73-79, 81, 84-86, 88-93, 95, 99-102, 104-106	lfidelity.....	16, 23, 25-26, 36	Seasons.....	168-172, 182-189
Ballpoint pens.....	225, 234-289	Isolating drinkware.....	207-211, 214	Security-friendly bags.....	47, 55, 57-58, 63, 79-81, 84, 86
Balmain.....	119, 147-148, 222-225, 238, 248-263	J		Serving sets.....	180, 193, 199
Bar sets.....	174-180, 191, 201-204, 213	Jamie Oliver.....	190-195	Shoulder bags.....	45-46, 48, 50-51, 55-58, 66-68, 71-73, 75-76, 79-80, 82-84, 90, 92, 94-97, 103, 106-107
Bath sets.....	168-169	Jars.....	186	Slazenger.....	88-97, 126-127, 135, 144-146
Bathrobes.....	172	Journalbooks.....	216-219	Smart phone accessories.....	28-36, 113
Battery chargers.....	14, 28-32, 35, 162, 246, 263	K		Smart phone sleeves.....	40, 118
BBQ tools.....	183	Key chains.....	112-113, 150, 260	Smart phone stands.....	16, 113
Binoculars.....	132-133	Keyboards.....	35	Solar powered items.....	29-30
Blankets.....	111, 189	Kitchen utensils.....	194	Speakers.....	12-17, 212
Bluetooth® items.....	12-17, 20-23, 25-26, 35, 212	Knives (kitchen).....	194-198	Spinners.....	63
Bottles.....	207-209, 211-212, 214	Knives (outdoor).....	113, 152-154, 156	Sports bags.....	67, 89-93, 99, 101
Bowling bags.....	96	L		STAC.....	158-163
Brief bags.....	47, 66, 71, 73, 75-76, 79-80, 82-84, 96	Lanterns.....	187	Storage items.....	110-112, 162-163, 186
BRIGHTravels.....	110-111	Laptop bags.....	45-48, 52-58, 60-61, 66-68, 78-87, 89, 92, 95, 99, 101, 103, 104-107	Styluses.....	236-239, 241, 244-246, 253-255, 257, 262-263
C		Laptop sleeves.....	42	Sunglasses.....	124-130
Cabin-approved luggage.....	60-61, 63, 77, 81, 87, 93	Laser presenters.....	246	T	
Cable management.....	32-35	Lens sets.....	36	Tablet bags.....	45-46, 53, 55-58, 68, 70-74, 82-83, 87, 99
Cables (charging).....	34-35, 113	Lights.....	112, 150-152, 157-162	Tablet sleeves.....	38, 40-42, 163, 230-231
California Innovations®.....	64-65	Luggage scales.....	117	Tablet stands.....	16, 41
Candles.....	187	M		Tea box.....	186
Car accessories.....	155, 159, 161-163, 166	Marksman.....	40-41, 70-77, 112-116, 120-122, 133, 140-143, 151-155, 196, 220-221, 230, 240-246	Tire gauges.....	159, 161
Carafes.....	176, 184, 190-191, 204	Measuring devices.....	160-161, 165	Tool sets.....	152, 159, 161, 164-166
Carry-on luggage.....	60-61, 63, 77, 81, 87, 93	Mechanical pencils.....	238, 261, 265, 282, 288-289	Torches.....	112, 150-152, 157-162
Case Logic.....	42, 82-87, 244	Media bags.....	97	Totes.....	45
Chargers.....	14, 28-32, 35, 162, 246, 263	Messenger bags.....	46, 58, 67, 71-73, 75, 80, 82-84, 90, 94, 103, 106	Towels.....	170-172
Charging cables.....	34-35, 113	Mobile accessories.....	16, 28-36, 113, 118	Travel bags.....	45, 47-48, 51, 59, 68, 74-75, 77, 80, 93, 96, 102-103, 111
Cheese sets.....	184, 193, 203	Mugs.....	213	Travel sets.....	110-110
Chess games.....	136	Multi function knives.....	152, 154, 156, 164	Travel wallets.....	114, 116-119, 258
Clocks.....	19	Multi function tools.....	154, 156, 159-161, 164	Trolleys.....	60-61, 77, 81, 87, 93
Clothes hangers.....	110	N		TSA-friendly bags.....	47, 55, 57-58, 63, 79-81, 84, 86
Cocktail sets.....	180, 213	NFC items.....	12-17	Tumblers.....	207-211
Coffee sets.....	185	Noise reduction items.....	23	U	
Compasses.....	132	Non-leaking drinkware.....	207, 209-210, 214	Umbrellas.....	138-148
Conference bags.....	45, 48, 50, 55-57, 71, 73, 75, 106-107	Notebooks.....	216-226, 260	US Basic.....	66-67, 124-125
Cook book stands.....	186	O		USB's.....	262-263
Cooler bags.....	64-65, 88, 183	Ogjo.....	104-108	W	
Coolers.....	175, 176, 179, 183, 201	Openers.....	174-175, 177-179	Waitress knives.....	174-175, 177-178, 191, 202-203
Corkscrews.....	174-175, 177-179, 191	P		Wallets.....	40, 115-119, 258, 260
Cups.....	185	Parker.....	265-278	Watches.....	120-122, 133
Cutlery.....	194	Passport wallets.....	114, 116-119, 258	Water resistant items.....	13, 51, 112, 157
Cutting boards.....	181, 193, 196, 199	Paul Bocuse.....	197-204	Waterman.....	280-286
D		Pen pouches.....	251, 259, 261, 270, 276, 285	Wheeled bags.....	60-61, 65, 77, 80-81, 87, 93
Decanters.....	176	Pen sets.....	225, 238-239, 241,	Whitelines.....	226
Duffel bags.....	47, 59, 80, 90, 95, 108	Pencils.....	238, 248, 261, 265, 282, 288-289	Wine accessories.....	174-179, 184, 191, 201-204
Dunlop.....	164-166	Pens.....	225, 234-289	Wine coolers.....	175, 176, 183, 201
E		Pepper mills.....	181, 200	Wine fridges.....	179
Earbuds.....	24-26	Phone accessories.....	28-36, 113	Wrist bands.....	132, 164
Elevate.....	98-103, 122, 128-130, 132-133, 156-157, 214	Phone sleeves.....	40, 118	X	
Elleven.....	78-81, 118, 211, 231	Phone stands.....	16, 113	X-mini.....	17
Emergency tools.....	155, 161-162	Photo frames.....	188	Z	
Energy packs.....	14, 28-32, 35, 162, 246, 263	Picnic sets.....	182	Zoom.....	15, 32, 212
Espresso sets.....	185	Picture frames.....	188		
F		Plaid.....	111, 189		
Field & Co.....	68-69	Portfolios.....	227-232		
Flashlights.....	112, 150-152, 157-162				



Avenue

WORLD SOURCE



WORLD SOURCE

Athena

Avenue®
CAREFULLY CONSIDERED GIFTS